



August
25 Cents

Radio-Craft

HUGO GERNSBACK Editor

Radio and
"Talkies"
Join Hands
See Page 70

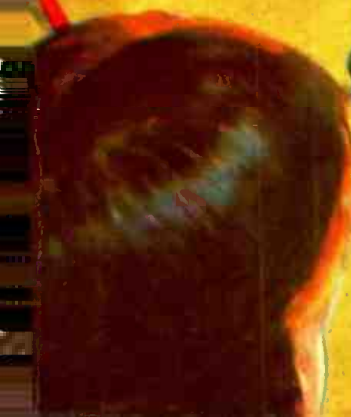
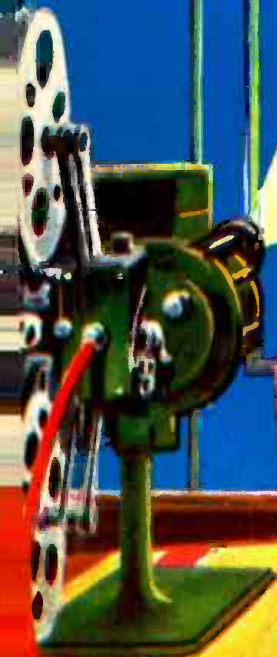

I Will Train You at Home to Fill a Big-Pay Radio Job



Here's the PROOF



**Has Made \$10,000
More in Radio**

"I can safely say that I have made \$10,000 more in Radio than I would have made if I had continued at the old job. When I enrolled with you I didn't know a volt from an ampere. I advise all ambitious young men to get into Radio. There is no greater opportunity."

Victor L. Osgood,
7101 Bay Parkway,
Brooklyn, N. Y.



**\$375 One Month in
Spare Time**

"Recently I made \$375 in one month in my spare time installing, servicing, selling Radio Sets."

Earle Cummings,
18 Webster St.,
Haverhill, Mass.



\$450 a month

"I work in what I believe to be the largest and best equipped Radio shop in the Southwest and also operate KGF1. I am averaging \$450 a month."

Frank M. Jones,
922 Guadalupe St.,
San Angelo, Tex.

If you are earning a penny less than \$50 a week, send for my book of information on the opportunities in Radio. It's FREE. Clip the coupon NOW. A flood of gold is pouring into this new business, creating hundreds of big pay jobs. Why go along at \$25, \$30 or \$45 a week when the good jobs in Radio pay \$50, \$75 and up to \$250 a week. My book, "Rich Rewards in Radio," gives full information on these big jobs and explains how you can quickly become a Radio Expert through my easy, practical, home-study training.

**Salaries of \$50 to \$250 a Week
Not Unusual**

Get into this live-wire profession of quick success. Radio needs trained men. The amazing growth of the Radio business has astounded the world. In a few short years three hundred thousand jobs have been created. And the biggest growth of Radio is still to come. That's why salaries of \$50 to \$250 a week are not unusual. Radio simply hasn't got nearly the number of thoroughly trained men it needs. Study Radio and after only a short time land yourself a REAL job with a REAL future.

**You Can Learn Quickly and Easily
in Spare Time**

Hundreds of N. R. I. trained men are today making big money—holding down big jobs—in the Radio field. Men just like you—their only advantage is training. You, too, can become a Radio Expert just as they did by our new practical methods. Our tested, clear training makes it easy for you to learn. You can stay home, hold your job, and learn quickly in your spare time. Lack of education or experience is no drawback. You can read and write. That's enough.

**Many Earn \$15, \$20, \$30 Weekly
on the Side While Learning**

My Radio course is the famous course "that pays for itself." I teach you to begin making money almost the day you enroll. My new practical method makes this possible. I give you SIX BIG OUTFITS of Radio parts with my course. You are taught to build practically every type of receiving set known. M. E. Sullivan, 412 73rd Street, Brooklyn, N. Y., writes, "I made \$720 while studying." Earle Cummings, 18 Webster Street, Haverhill, Mass.: "I made \$375 in one month." G. W. Page, 1807 21st Ave., Nashville, Tenn.: "I picked up \$935 in my spare time while studying."

Your Money Back If Not Satisfied

I'll give you just the training you need to get into the Radio business. My course fits you for all lines—manufacturing, selling, servicing sets, in business for yourself, operating on board ship or in a broadcasting station—and many others. I back up my training with a signed agreement to refund every penny of your money if, after completion, you are not satisfied with the course I give you.

**Act Now—64-Page
Book is FREE**

Send for this big book of Radio information. It won't cost you a penny. It has put hundreds of fellows on the road to bigger pay and success. Get it. Investigate. See what Radio has to offer you, and how my Employment Department helps you get into Radio after you graduate. Clip or tear out the coupon and mail it RIGHT NOW.

J. E. SMITH, President
Dept. 9 V 95
National Radio Institute
Washington, D. C.

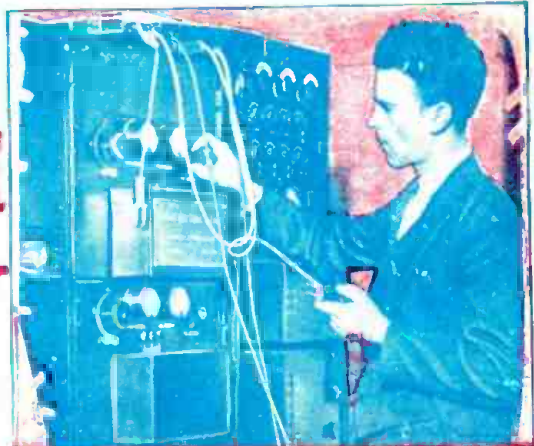

**You can build
100 circuits with
the six big outfits
of Radio parts
I give you**

**3 of the 100 you
can build**



**Find out quick
about this
practical way
to big pay**



Mail This FREE COUPON Today

J. E. SMITH, President
Dept. 9 V 95, National Radio Institute
Washington, D. C.

Dear Mr. Smith: Kindly send me your big book, "Rich Rewards in Radio," giving information on the big-money opportunities in Radio and your practical method of teaching with six big outfits. I understand this book is free, and that this places me under no obligation whatever.

Name Age.....
Address
City State.....
Occupation

**Employment Service to all Graduates
Originators of Radio Home Study Training**

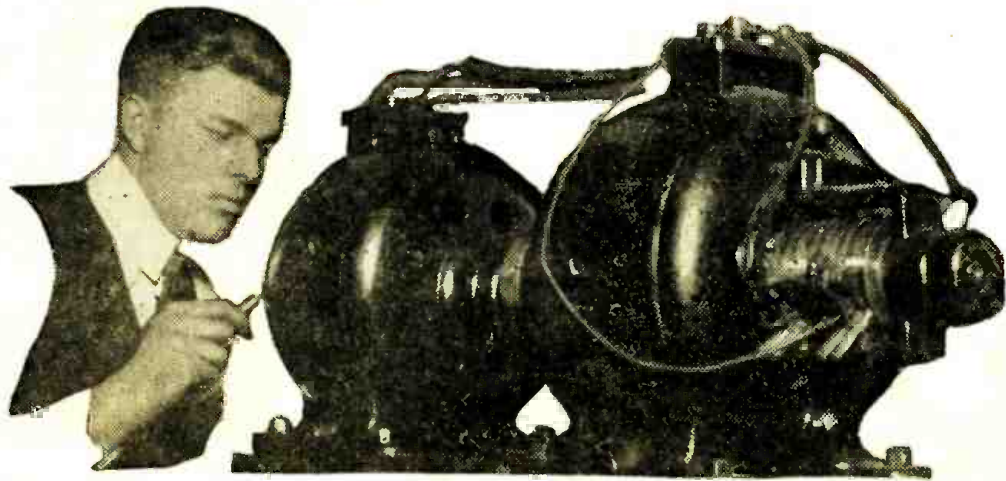

Amazingly Easy Way to get into ELECTRICITY

Don't spend your life waiting for \$5.00 raises in a dull, hopeless job. Now . . . and forever . . . say good-bye to 25 and 35 dollars a week. Let me show you how to qualify for jobs leading to salaries of \$50, \$60 and up, a week, in Electricity—NOT by correspondence, but by an amazing way to teach, that makes you a practical expert in 90 days! Getting into Electricity is far easier than you imagine! Act now, today!

Learn Without Books in 90 DAYS

LACK of experience—age or advanced education bar no one. I don't care if you don't know an armature from an air brake—I don't expect you to! I don't care if you're 16 years old or 40—it makes no difference! Don't let lack of money stop you. Most of the men at Coyne have no more money than you have.

Railroad Fare Allowed

I will allow your railroad fare to Chicago, and if you should need part-time work I'll assist you to it. Then, in 12 brief weeks, in the great roaring shops of Coyne, I train you as you never dreamed you could be trained . . . on the greatest outlay of electrical apparatus ever assembled . . . costing hundreds of thousands of dollars . . . real dynamos, engines, power plants, autos, switchboards, transmitting stations . . . everything from doorbells to farm power and lighting . . . full-sized . . . in full operation every day!

No Books—All Actual Work
No books, no baffling charts . . . all



Prepare for Jobs Like These

Here are a few of hundreds of positions open to COYNE-trained men. Our free employment bureau gives you lifetime employment service.

Armature Expert	up to \$100 a Week
Substation Operator	up to \$65 a Week
Auto Electrician	\$60 a Week and up
Inventor	Unlimited
Maintenance Engineer	up to \$100 a Week
Service Station Owner	\$60 a Week and up
Radio Expert	\$60 a Week and up

real actual work . . . building real batteries . . . winding real armatures, operating real motors, dynamos and generators, wiring houses, etc., etc. That's a glimpse of how we make you a master practical electrician in 90 days, teaching you far more than the average ordinary electrician ever knows and fitting you to step into jobs leading to big pay immediately after graduation. Here, in this world-famous *Parent school*—and nowhere else in the world—can you get such training!

Jobs, Pay, Future

Don't worry about a job, Coyne training settles the job question for life. Demand for Coyne men often exceeds the supply. Our employment bureau gives you lifetime service. Two weeks after graduation,

Clyde F. Hart got a position as electrician with the Great Western Railroad at over \$100 a week. That's not unusual. We can point to Coyne men making up to \$600 a month. \$60 a week is only the beginning of your opportunity. You go into radio, battery or automotive electrical business for yourself and make up to \$15,000 a year.

AVIATION ELECTRICITY



Students wiring and checking ignition on one of the late type Radial Aircraft Engines in our aviation department.

I am including my new Aviation Electricity course as well as Radio and Automobile Electrical courses to all who enroll now.

Get the Facts

Coyne is your one great chance to get into electricity. Every obstacle is removed. This school is 30 years old—Coyne training is tested—proven beyond all doubt—endorsed by many large electrical concerns. You can find out everything absolutely free. Simply mail the coupon and let me send you the big, free Coyne book of 150 photographs . . . facts . . . jobs . . . salaries . . . opportunities. Tells you how many earn expenses while training and how we assist our graduates in the field. This does not obligate you. So act at once. Just mail coupon.

Get this FREE Book



Mr. H. C. LEWIS, Pres.
COYNE ELECTRICAL SCHOOL Dept. C9-95
500 S. Paulina St., Chicago, Ill.

Dear Mr. Lewis: Without obligation send me your big free catalog and all details of Railroad Fare to Chicago, Free Employment Service, Aviation, Electricity and Automotive Electrical Courses and how I can "earn while learning."

Name.....
Address.....
City..... State.....

COYNE
500 South Paulina Street

ELECTRICAL SCHOOL
H. C. LEWIS, Pres. Established 1899
Dept. C9-95 Chicago, Illinois



VOLUME I.

August

NUMBER 2

HUGO GERNSBACK, Editor-in-Chief

R. D. Washburne, Technical Editor.

C. P. Mason, Associate Editor

Contents of This Issue:

	PAGE		PAGE
EDITORIAL—"MAKE MONEY IN RADIO." Hugo Gernsback	53	SHORT WAVE CRAFT	
RADIO-CRAFT CONSTRUCTOR		A COMPLETE PORTABLE TRANSMITTER AND RECEIVER, Lawrence B. Robbins	68
A "COLOR CURTAIN" FOR CABINET GRILLS, G. F. Prideaux	54	SOME NOTES ON SHORT-WAVE OPERATION, Robert Hertzberg	71
THE MOORE-DANIELS RECEIVER.....Alfred J. Daniels	56	HOW TO BUILD A TWO-IN-ONE RECEIVER, Louis B. Sklar	72
CONE DIAPHRAGMS AND SECTOR DIAPHRAGMS, Dr. Eugene Nesper	60	LATEST THINGS IN RADIO.....	74
A TYPE '45, PUSH-PULL, POWER AMPLIFIER CIRCUIT..	61	RADIO CRAFT KINKS.....	76
HOW TO BUILD A GIANT FREE-EDGE CONE REPRODUCER, Louis Gancher	62	SERVICE MAN'S DATA	
HOME TALKIES WITH YOUR RADIO, A. Pam Blumenthal	64	THE ADELMAN UNIVERSAL TESTER..Leon L. Adelman	78
RADIO FOR MOTION PICTURE THEATRES..W. L. Woolf	66	THE COOPERATIVE RADIO LABORATORY....	82
		INFORMATION BUREAU.....	84
		BOOK REVIEW.....	92

In The September Issue

- The "Screen Grid" Peridyne.....Hugo Gernsback
 - This article by Mr. Hugo Gernsback describes in detail the construction of the most improved Peridyne available today, surpassing all previous forms of the Peridyne.
- Putting New Life in Old Supers.....R. H. Siemens
 - A method of obtaining stable and high-gain amplification in a circuit incorporating standard '01A tubes is disclosed in this article by Mr. Siemens.
- Servicing the Broadcast Receiver.....Julius G. Aceves
 - This article of interest to every owner of a radio set includes two tables which render set servicing a much speedier operation.
- A Bureau of Standards Audio Amplifier...S. R. Winters
 - The technical difficulties encountered during the design of an unusual type of audio amplifier and the eventual solution of these problems are described in this article.

RADIO-CRAFT is published on the 5th of the preceding month. 12 numbers per year. subscription price is \$2.50 a year in United States and its possessions. In Canada and foreign countries, \$3.00 a year. Single copies 25c. Address all contributions to Editor, RADIO-CRAFT, 96-98 Park Place, New York. Publishers are not responsible for lost Mss. Contributions cannot be returned unless authors remit full postage.

RADIO-CRAFT—Monthly—application for second class matter in the Postoffice of New York, under the act of March 3, 1879, pending. Title registered U. S. Patent Office. Trademarks and copyrights by permission of Gernsback Publications, Inc., 98 Park Place, New York City, owner of all trademark rights. Copyright 1929, by G. P., Inc. Text and illustrations of this magazine are copyright and must not be reproduced without permission of the copyright owners.

RADIO-CRAFT is for sale at all principal newsstands in the United States and Canada. European agents: Brentano's, London and Paris. Printed in U. S. A. IF YOU WISH TO SUBSCRIBE TO RADIO-CRAFT, make out all remittances to the Techni-Craft Publishing Corp., 96-98 Park Place, New York City. Be sure to mention the name of magazine you wish to subscribe for, as we are also agents for the following magazines: SCIENCE WONDER STORIES and AIR WONDER STORIES, subscription price of which is the same as RADIO-CRAFT. Subscriptions can be made in combination with the above publications, at a reduced club rate. Ask for information. Subscriptions start with current issue. WHEN YOUR SUBSCRIPTION EXPIRES, we enclose a renewal blank in the last number. No subscriptions continued unless renewal remittance received. Change of Address. Always give us old as well as new address and notify us as far in advance as possible.

This magazine is published by

TECHNI-CRAFT PUBLISHING CORPORATION

H. GERNSBACK, President S. GERNSBACK, Treasurer JOSEPH M. HERZBERG, Vice-President IRVING S. MANHEIMER, Secretary

Chicago Advertising Representative: L. F. McCLURE, 737 North Michigan Avenue

Editorial, Advertising and General Offices 96-98 Park Place, New York City



5 Easy Ways to Make \$3.00 an hour in Your Spare Time in RADIO

Each of these plans, developed by the Radio Training Association of America, is a big money-maker. Set owners everywhere want to get rid of static, to have their sets operate from the electric light socket, the tone improved, and the volume increased, and transformed into single-dial controls. Phonograph owners want their machines electrified and radiofied. If you learn to render these services, you can easily make \$3.00 an hour for your spare time, to say nothing of the money you can make installing, servicing, repairing, building radio sets, and selling supplies. Over \$600,000,000 is being spent yearly for sets, supplies, service. You can get your share of this business and, at the same time, fit yourself for the big-pay opportunities in Radio by joining the Association.

Join the Radio Training Association of America

A membership in the Association offers you the easiest way into Radio. It will enable you to earn \$3.00 an hour upwards in your spare time—train you to install, repair and build all kinds of sets—start you in business without capital or finance an invention—train you for the \$3,000 to \$10,000 big-pay radio positions—help secure a better position at bigger pay for you.

A membership need not cost you a cent!
The Association will give you a comprehensive, practical, and theoretical training and the benefit of its Employment Service. You earn while you learn. Our cooperative plan will make it possible for you to establish a radio store. You have the privilege of buying radio supplies at wholesale from the very first.

Earned \$500.00 Spare Time
Frank J. Deutsch, Penn.: "I have made over \$500 out of Radio in my spare time."

Radio Engineer In One Year
Claude De Grave, Canada: "I knew nothing about Radio when I joined a year ago. I am now a member of a very exclusive organization of Radio Engineers, and my income is 225% greater than it was."

Doubles Income In 6 Months
W. E. Thon, Chicago: "Six months after I enrolled I secured the managership of large Radio Store and doubled my income."

ACT NOW — If You Wish the No-Cost Membership Plan

To a limited number of ambitious men, we will give Special Memberships that may not—need not—cost you a cent. To secure one, write today. We will send you details and also our Radio Handbook filled with dollars-and-cents radio ideas. It will open your eyes to the money-making possibilities of Radio.

Radio Training Association of America
4513 Ravenswood Avenue, Dept. RCA-8 Chicago, Ill.

Radio Training Association of America
Dept. RCA-8 4513 Ravenswood Ave., Chicago, Ill.
Gentlemen: Please send me by return mail full details of your Special Membership Plan, and also copy of your Radio Handbook.

Name

Address

City State

Become a Trained Radio-Technician

Station WISN Is Operated From School of Engineering

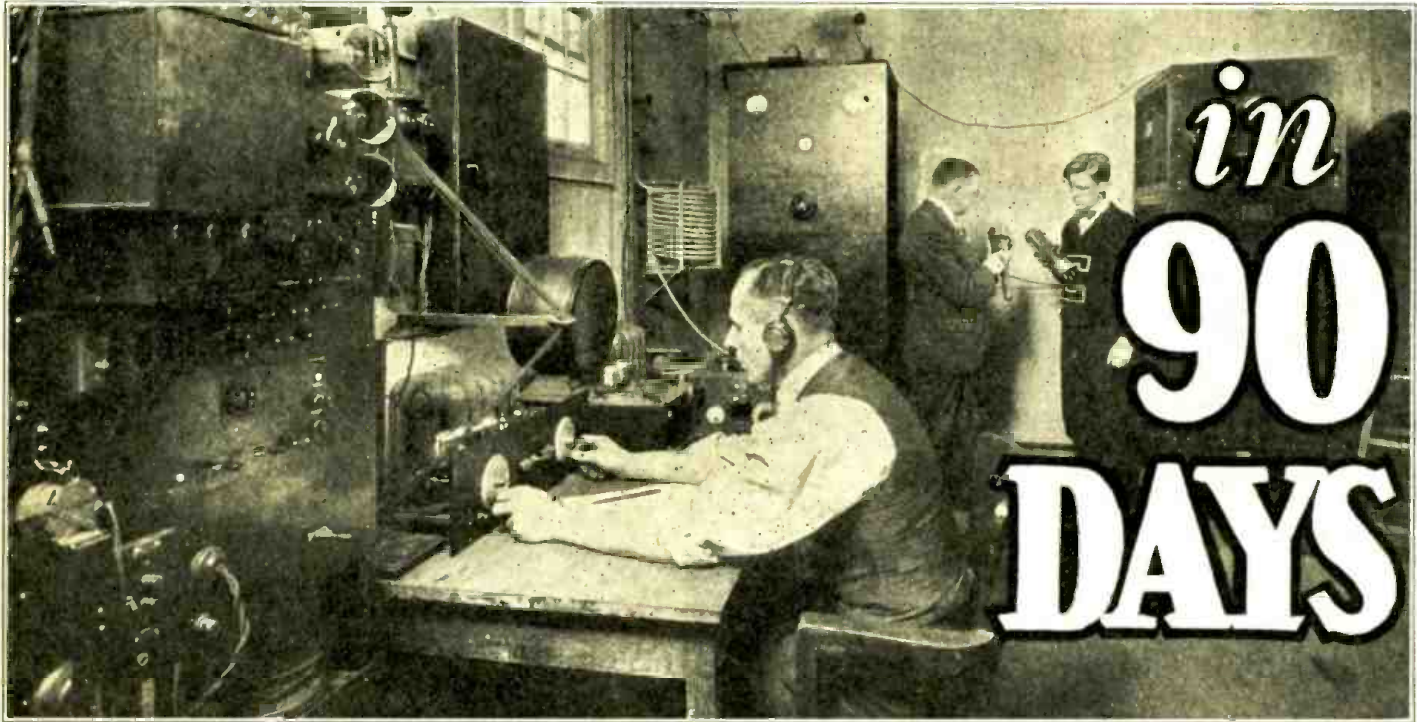
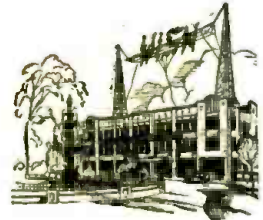

Michael Ert, Pres. Michael Ert, Inc. and Pres. Wis. Radio Trades Ass'n. and First V. Pres. Federated Radio Trades Ass'n., approves radio course as taught in School of Engineering of Milwaukee.

RADIO INDUSTRY PLEADS For "Registered" Radio Experts

Opportunity beckons as never before in the Radio Industry. Good paying positions, interesting work, a chance to become independent—radio offers all this and more to ambitious men who seize the opportunity NOW!

Radio Trades Association Approves School of Engineering's Radio Graduates

The Wisconsin Radio Trades Ass'n now compels every radio service man to pass severe examinations and become registered. Dealers are tired of expensive, incompetent help. Radio trade associations the country over are planning to

follow Wisconsin's example. The School of Engineering is the only institution in the country whose course is approved by a radio trade association. Graduates of the S. of E. are "registered" without examination.

Television Included

Complete Radio Course also includes study of fundamentals of Television and latest developments in that gigantic new field. Enables anyone to keep up with progress of this new industry.

MOST THOROUGH AND PRACTICAL RADIO COURSE IN AMERICA!

Here in this big splendidly equipped electrical school (from which Station WISN is operated) you can secure in three months the most thorough, the most compact and practical radio training offered anywhere. Covers entire field of radio! Complete course includes Radio Laboratory Practice, Radio Telephony Theory, Radio Transmission, Code Instruction, Electrical Mathematics, Service and Installation, Radio Sales and Merchandising. Daily broadcasting from WISN. All training is 100% practical. You learn everything in three short months!

Earn While You Learn Send for Free Book

Not only do we help place our men after graduation, but we can arrange for part-time employment for ambitious men who can finance their tuition. This will cover part if not all of your living expenses while you are taking the Radio Course at the School of Engineering.

Send today without obligation, for FREE catalog describing the wonderful opportunities in radio, the three month Radio Course, and details of our Earn While You Learn Plan.

School of Engineering of Milwaukee, Dept. RC 829, Milwaukee, Wis.

Without obligation, please send me FREE Book describing your 3 months' "Radiotrician" course and full details of your "Earn While You Learn Plan."

Name..... Age.....

Address

City..... State.....

SCHOOL of ENGINEERING of Milwaukee
Founded 1905 Dept. RC 829 Milwaukee, Wis.



HUGO GERNSBACK.

Editor

EDITORIAL AND GENERAL OFFICES, 96-98 PARK PLACE, NEW YORK.

Make Money in Radio

By HUGO GERNSBACK



DESPITE the contrary opinion held by individuals and particularly by radio experimenters, set builders, repairmen, service men, there is still a good deal of money to be made in radio today. As a matter of fact and stating it mildly, there is more money to be made in radio by individuals than ever before.

Many people are of the opinion that, because the main radio business is now centered in the set market, very little money is to be made outside of selling sets. This is not true. The reverse of this situation is true; as the following clearly demonstrates.

This is the day when the individual and the man of small means who has resourcefulness and good business sense can make quite a considerable amount of money out of radio either in his spare time, as a hobby, or as a regular business.

Firstly, there is a good deal of money to be made by "reconditioning" sets. Practically every store, and particularly the larger ones, have any number of second-hand old-fashioned sets on hand that in many cases can be bought almost for the asking. Practically every store that does a good business in sets must, as a regular course of business, take old sets as "trade ins." Now, most of these sets usually are in poor condition, but the individual who knows something about radio repair work has little trouble in reconditioning such sets. We have seen many cases where 5-tube sets that sold from \$60.00 up to \$150.00 when they were new can be bought for \$5.00 to \$25.00, while the average price very seldom is above \$10.00.

It is true that these sets may be old-fashioned and may look like a wreck when bought, yet, with a little ingenuity, and a few hours spent in reconditioning them, all can be sold at a profit of 100 to 300 percent.

There are at the present time a good many individuals who make it a business to frequent radio stores where such sets are sold, particularly those stores that do a large installment business. Very often the owners of such stores are willing to get rid of their second-hand trade-in sets if the individual is willing to do a little servicing on their regular sets. At certain seasons of the year, the radio stores are, as a rule, short of service men, and are only too glad to part with their second-hand sets in exchange for services. In that case, of course, the profit in reconditioned sets is even better.

It is suggested that the individual interested in reconditioning sets have a letterhead printed and circularize a number of stores, which need not be necessarily in the same city. It is announced that the writer is always in the market for second-hand sets and he inquires of the dealer what sets he has to dispose of as well as the quantity.

The next thing to do is to write to the manufacturers of the sets and ask them for the service bulletins, stating the model of the particular set. In these service bulletins which every manufacturer gets out, a lot of valuable data is contained that comes in exceedingly handy when the set has to be taken apart and reconditioned.

In most cases, the trouble in the old set is minimal. As a rule, the only trouble is in broken connections or blown-out transformers. Most mail order houses now sell replacement transformers at prices from 60c up. Quite a few particularly good transformers of this type are available and will work wonders in many old sets. After the set has been repaired, from the electric and radio standpoint, it is then of course necessary to put the cabinet into first-class shape. This also is a simple affair, because practically every varnish and paint house in the country and every store that sells paints and varnishes has a number of preparations for refinishing

woodwork. Holes and dents can be filled up and after intelligent and careful treatment, it will be difficult for anyone to determine that the cabinet is not a new one.

Of course most of the sets taken in trade today are of the battery variety. That, however, should be no detriment because, with very little expense, a power pack or an eliminator system can either be installed right into the set itself or placed inside the cabinet if it is of the "console" variety, thus making an all-electric set out of it. Inasmuch as such reconditioned sets can be sold at a price vastly reduced from that of regular sets, people of small means are willing to buy such sets. Again, the method of selling these sets is simple enough once you know the knack.

The best way to sell such sets is not in an outright sale, but by offering to leave the set "on consignment" for a week. If you get permission to install the set on the premises and it performs well, you will have little trouble in collecting the full amount at the expiration of the trial period.

A number of individuals have even gone as far as to compete with a regular set dealer to the extent of selling such sets on the installment plan. Usually, a down payment of \$10.00 or more is made and the balance paid at the rate of a few dollars a month. This is good business because, in most cases, the down payment practically pays for the whole outlay and whatever money comes in later is just that much profit. Thus, if the constructor can make a few sales during the week, he is assured of an extra income that he would not have otherwise.

Incidentally, there will be the sale of "extras," inasmuch as tubes, batteries, aerial equipment, etc., are of course sold separately, and usually these are sold at a good profit. There are vast opportunities today in this business and those who have a little initiative can cash in on it.

There is one little store in downtown New York which does a business of selling only "reconditioned" sets and in an interview with the owner, the astonishing information was disclosed that he made \$18,000 net profit last year in selling such sets. This store in many cases does not even bother to recondition some of the sets that are too hopeless; these are sold to experimenters for as little as \$1.00 for a five-tube set. This may not sound very profitable but this gets them off the shelf and it must be appreciated that this store does not pay more than 25 cents for some of these sets!

Another extra source of income for the individual of small means is available if he will watch the building of new apartment houses as they go up. The builder or landlord should be approached and the idea should be sold him that his house should not be disfigured with a mess of unsightly aerial wires. At a small cost, uniform aerials can be stretched on the roof two or three feet apart, all uniformly put up by having light iron work "T" angles spaced from one end to the other of the building and then stretching the individual aerials in between. A local blacksmith or iron worker will make the iron work at a small cost and the actual cost of wiring comes very low to the builder; while he will appreciate the fact that his building is not disfigured.

The builders of "high class" apartment houses are employing the service man to install the latest idea in aerials, which necessitates only a single wire for serving a group of approximately ten apartments through the use of individual "blocking tube" feeder units housed in some sheltered portion of the roof.

From time to time I will give some hints on how to make money in radio along these lines.



A "Color Curtain" For Cabinet Grills

The new vogue in cabinet design, as evidenced by displays at the Chicago Show, is a changing light effect for reproducer grills of radio cabinets.

By G. F. PRIDEAUX*

BEFORE we delve into the intricacies of the Color Curtain, let us state that the colors seen are entirely independent of the radio mechanism.

cabinet. Another, and perhaps more convenient, way is to screw the cylinder holders directly to the base of the cabinet. The two-hole mounting which is part of the kit makes this possible.

If it is desired to incorporate the color screen in a cabinet which includes a dynamic reproducer, it will be necessary to mount the reproducer on a baffle which can be mounted back about four inches from the grille. It is possible that some forms of cabinet construction may not permit mounting the baffle four inches from the grille, F, without introducing a slight "barrel effect" in the reproduction. However, a four-inch depth should not prove objectionable. Mag-

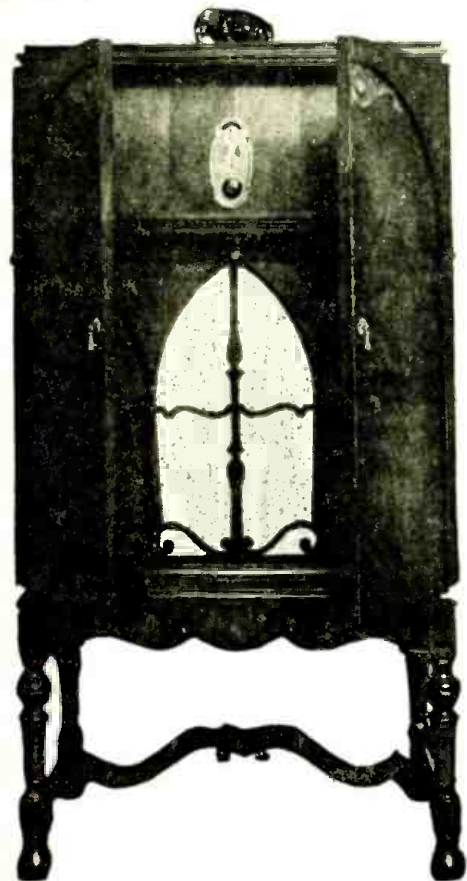

A standard console with color screen visible. Service men should capitalize this idea.

Method of Operation

One "color cylinder" is placed at each end of the screen covering the sound aperture in radio cabinets; these two cylinders are very slowly rotated by a small electric motor. A lamp placed inside each cylinder is continuously lit, and this light is filtered by the rotating color cylinders; the filtered light falling on the screen across the cabinet opening and the changing colors appearing to "melt" from one extreme to another.

Constructional Details

Fig. 1 illustrates the usual method of mounting the color cylinders inside a

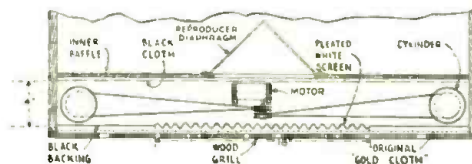

Correct placement of the color screen mechanism.

netic type reproducers need not be mounted on a baffle, of course. It is necessary only to place one about four and a half inches from the color curtain, and drop a black cloth curtain one-half inch in front, as shown (E).

The color cylinders are made by overlapping strips of colored, transparent material ("Protectoid"). The strips are all eight inches long. The widths recommended or balance are red, 2½ inches; blue, 3¼ inches; yellow, 2 inches; green, 2½ inches. As the diameter of the completed cylinder is three inches, it will be found that the strips overlap to a distance for fastening.

The mounting feet require four inches base room, and the over-all height is ten inches.

There is a pulley on each cylinder and these two cylinders and the motor drive are geared with cord, such as fish line. The best speed for the cylinders is about one revolution per minute on the average, (the right cylinder turning faster than this and the left one turning slower, due to the two cylinder pulleys having different diameters. A change in ratio is obtained by reversing the pulleys.)

The kit of parts obtainable includes a small four-watt, brushless, non-synchronous induction type motor (3,600

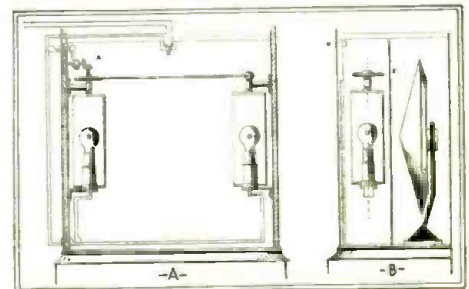
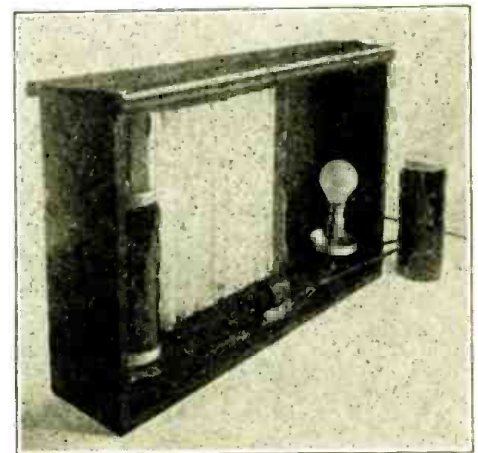

Fig. 1. Another way of allocating the parts.

R.P.M.) and correct reduction-gear system. (Also, two color cylinders, pulleys, hardware, coupling cord, power switch, lamp sockets, opaque cloth, and color curtain material.) This type of motor causes no "static" in the radio.

The 25-watt, 115-volt inside-frosted Mazda lamps, D, are the right type.

These and the motor are controlled by the push-pull switch, B, mounted on the grill, and operated by closing the door.



Rear view of a portable demonstrator. The curtain forms an 18-inch square.

The Color Curtain

Most grilles are open over their full area. These must be blocked up with black cloth, except for the central space required for the white screen to prevent the cylinders from being seen directly.

This screen should not be flat, but should have half-inch pleats. (These correct a rotating "barber pole" effect.) On the pleated curtain, the lines of color demarkation disappear and an enchanting stage illusion is obtained.

*Engineering Department, Edison Lamp Works, General Electric Company

Air Wonder Stories

AIR WONDER STORIES, which contains Flying Stories of the Future, is a fitting sister magazine to SCIENCE WONDER STORIES. It is a revelation in science fiction stories of the air. Be sure to reserve a copy now or make yourself sure of it by subscribing.

Big Magazine
Size 9 x 12"
4 Color Cover



The Copy
25c

On All
Newsstands

CONTENTS

August Air Wonder Stories

THE SILENT DESTROYER
By Hendrik Dahl Juve

BEYOND GRAVITY
By Ed Earl Repp

THE ARK OF THE COVENANT (Part II)
By Victor MacClure

WHERE GRAVITY ENDS
By Robert H. Leitfeld

THE PLANET'S AIR RULER
By Edward E. Chappelow

WHAT IS YOUR AVIATION KNOWLEDGE?
Aviation Questionnaire

AVIATION NEWS OF THE MONTH
THE READER AIRS HIS VIEWS
Letters from Our Readers

Special Subscription Price
8 Issues \$1.00

STELLAR PUBLISHING CORPORATION
Dept. RC8, 96-98 Park Place
New York, N. Y.

Enclosed find \$1.00 for which enter my subscription for 8 (eight) months to your monthly magazine, "Air Wonder Stories".

Name

Address

City and State

Science Wonder Stories

DRAMATIZED MECHANICS

Stories with a
Scientific
Background

Big Magazine
Size 9 x 12"
4 Color Cover

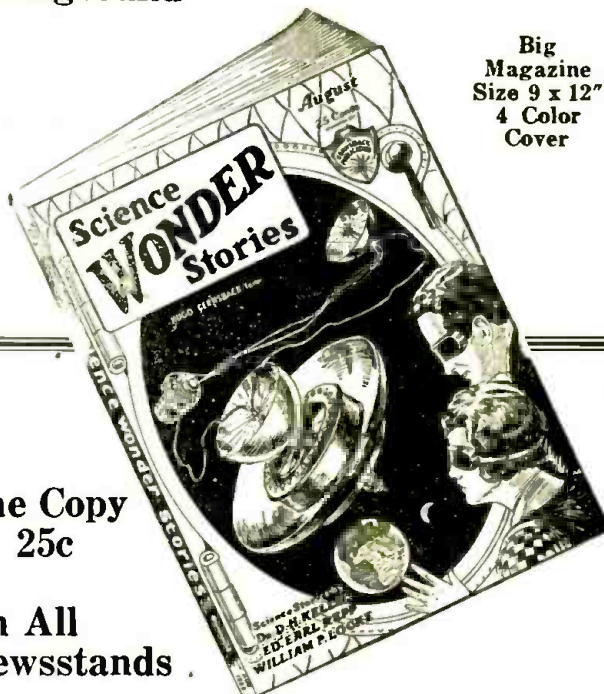

The Copy
25c

On All
Newsstands

CONTENTS

August Science Wonder Stories

THE ALIEN INTELLIGENCE
By Jack Williamson (Part II)

THE MOON BEASTS By William P. Locke

THE FEMININE METAMORPHOSIS
By David H. Keller, M.D.

THE RADIUM POOL By Ed Earl Repp (Part I)

PROBLEMS OF SPACE FLYING
By Capt. Hermann Noordung, A.D.M.E. (Part II)

THE ETERNAL MAN By D. D. Sharp

SCIENCE NEWS OF THE MONTH

"WHAT SCIENCE FICTION MEANS TO ME"
Prize Contest Letters

"THE READER SPEAKS" Letters from Readers

WHAT IS YOUR SCIENCE KNOWLEDGE?
Science Questionnaire

Special Subscription Price
8 Issues \$1.00

STELLAR PUBLISHING CORPORATION
Dept. RC8, 96-98 Park Place
New York, N. Y.

Enclosed find \$1.00 for which enter my subscription for 8 (eight) months to your monthly magazine, "Science Wonder Stories".

Name

Address

City and State

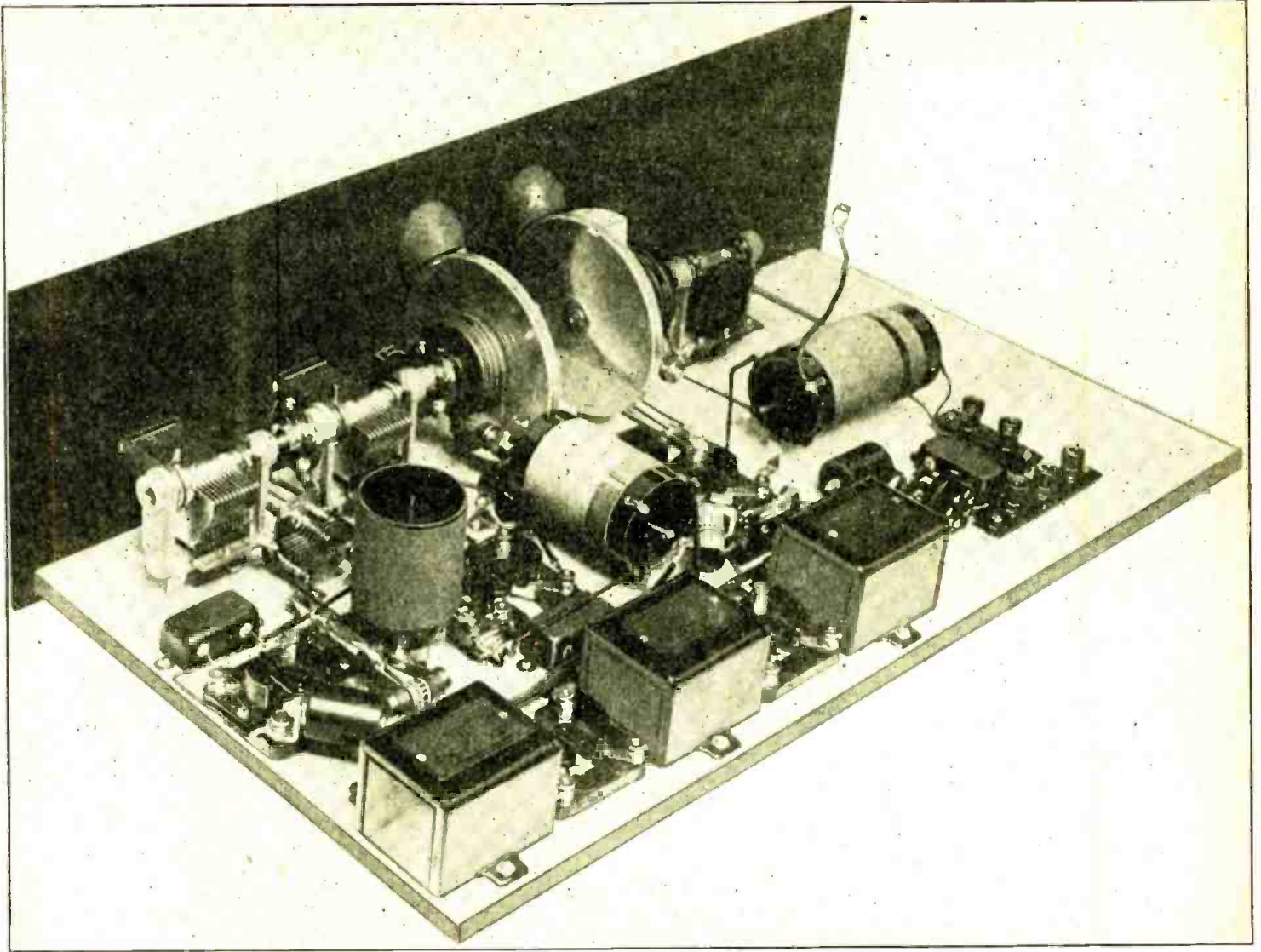

Rear perspective of the Moore-Daniels, showing the neat arrangement of parts.

which render it distinctive lie entirely in the radio-frequency and detector circuits, which may be employed in connection with any variety of audio amplifying system. The proof of its practicability and freedom from eccentricities is the fact that it works up equally well for either battery or all-electric operation, and that its output will energize equally well any sonic amplifier. It is an unfortunate characteristic of most of the sensitive receivers of the past, which were to a great extent founded on "trick" circuits, that in order to secure proper operation on one type of supply, adjustments were necessary which had a very deleterious effect when used in other ways; but none of the "bugs" usually encountered in one or the other arrangement will be encountered by the builder of this circuit. The battery design may, of course, be used with any good "A" and "B" eliminator and, due to the steady output of set units, will usually be found to function, when so used, to just a trifle better advantage than is possible with batteries.

Fundamentally there is little that is new about the receiver. The aim of the designers was toward producing the best possible operation, and in the course of several months' experimentation, portions of almost every receiver design which has been offered in many years, were tried. Some were chosen, some were found wanting, and the final result will

be seen to contain the best features of many well-remembered circuits; although it is unique in its sensitivity and comparatively low in its first cost. Reduction of the number of controls and of the cost of the components, was, of course, an object, but was not allowed to effect the quality of the result in any way.

Receiver Characteristics

Looking at the front of the panel, we find two attractive and smooth-turning drum dials, with their controls, and two other knobs. For the reception of local stations only one of the latter need be used, as a volume control, but the other will be found extremely useful in the reception of the elusive far-away stations whose reception is the proud accomplishment of every DX lover.

One of the outstanding features of the set is the availability of each of these controls, without having them "inter-link" at all in operation; in no case will the adjustment of any control be found to necessitate the readjustment of any other.

Let us revert to the circuit diagram and look at it, section by section. First, we find that the method of antenna coupling employed here comes down to us from the earliest days of radio, when the "loose coupler" (or as it was later termed "vario-coupler") was the major instrument of every receiver. This par-

ticular feature was used last year by Mr. Moore in the same way in the popular "Everyman".

In the Moore-Daniels receiver there has been incorporated a refinement of design which is extremely simple; but this feature makes possible the astounding selectivity which brings in both Chicago and New York stations in either city, even when locals only 10 "kilohertz" (kilocycles) away are in full swing. In operation, it will be found that there is a position of the primary coil which will perfectly balance out the signals from even a powerful local; but, in the maximum position, very tight coupling is obtained. For local reception this control may be used for very effective volume variation, rendering possible the reduction of the incoming signal to a value where even the most powerful local will not tend to overload any of the tubes.

In this radio-frequency stage the same general type of tuning and filament-control circuits are employed as those with which Mr. James Millen achieved wonderful results in the famous screen-grid receiver he designed for the National Company of Malden, Mass. The use of the .0005 tuning condenser makes complete coverage of the broadcast band easy, and the variable resistance in the filament circuit assures the operation of the screen-grid tube at its most effective point.

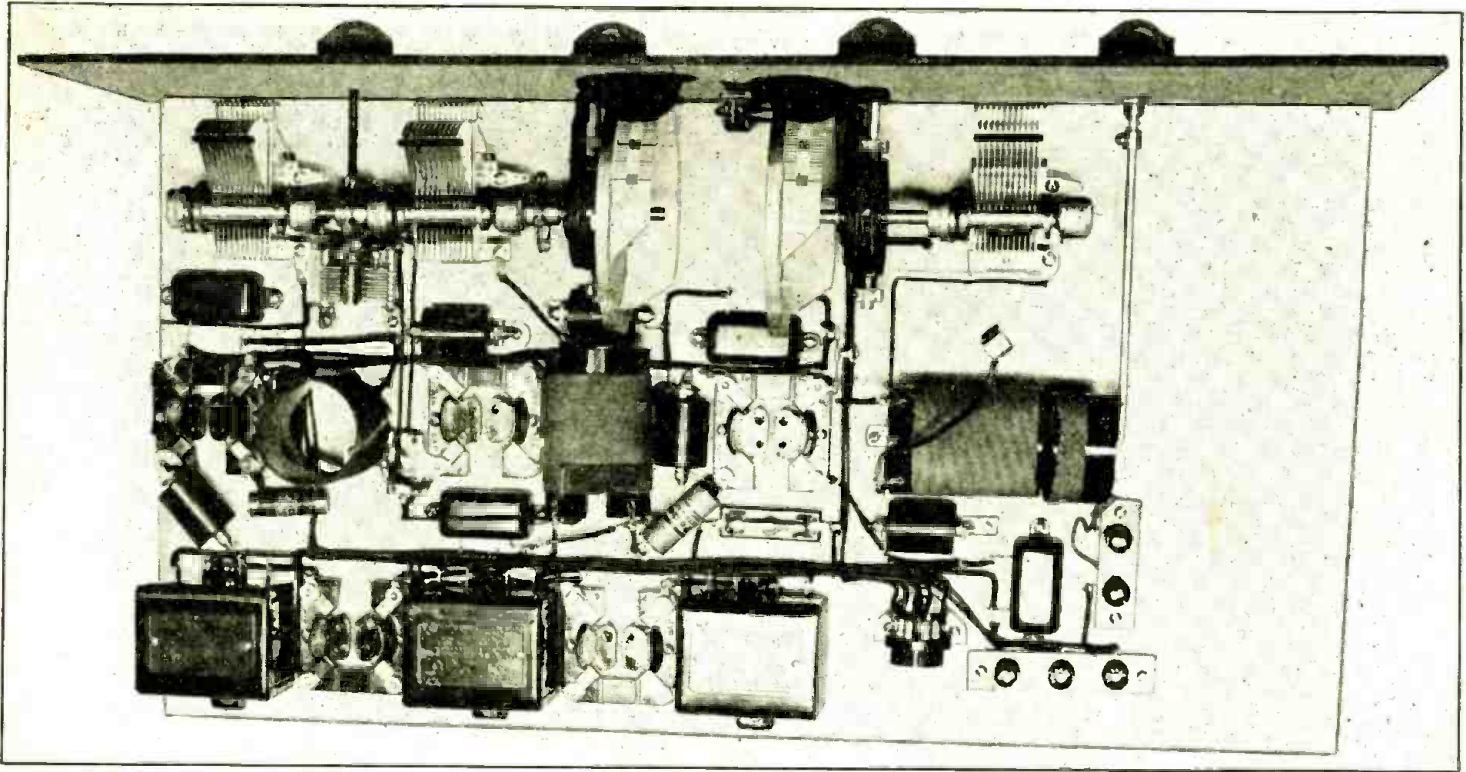

Another view of the composite circuit described by Mr. Daniels. Shielding is conspicuous by its absence. The method of coupling variation in the antenna circuit is clearly shown. The radio frequency coils must not be placed any closer than as shown. The exceptional performance of this receiver is an indication of what can be done toward the elimination of shielding by proper application of engineering principles.

Stabilizing Method

Efficient coupling between the first and second radio-frequency stages is accomplished by a further development of the "Chronophase" system which, in a cruder and less finished form was utilized by the writer in the Aero broadcast receivers last summer.*

Even in its previous form this system resulted in far more of the theoretical amplification of the screen grid tube being available than in other T.R.F. circuits where attempts had been made to utilize this tube. Since that time an extension of the elaborate course of research and experimentation which resulted in its adoption has been continued until, as it is utilized in this circuit, all of the amplification combined with selectivity (which was its chief feature) has been retained; but with complete elimination of the need for a separate oscillation control for this stage. The output of this improved "Chronophase" system works into a second radio-frequency stage in which a standard "all-purpose" tube is utilized.

Both input and output circuits of this second output stage have been adapted from the Western Electric "Betts" circuit which is one of the oldest R.F. regenerative systems and one which has left a noble heritage of successors in the "L.C.," the "Browning-Drake," "Roberts", "Everyman", and many other popular circuits.

Complete neutralization of the undesirable feed-back effects, resulting from the grid and plate capacity of the tube over the entire band allotted to broadcast frequencies, has been accomplished by the combination of the well known "Rice" balancing system, and the grid-stabilizer system which has been adopted of late

by almost every commercial manufacturer of high-grade radio receivers, with excellent results.

It will be noted that the usual practice of placing the stabilizing resistor directly against the grid of the tube has been avoided. In such a connection it interferes with the capacity neutralization and introduces unnecessary losses which can be avoided by insertion in the *grid return*.

Avoiding Regeneration Pitfalls

Extreme sensitivity is obtained in the detector input circuit both by taking advantage of the very close coupling obtained in the use of the auto-former coupler between the plate circuit of the screen-grid R.F. tube and the grid of the detector, and by the use of a carefully-designed capacity-feedback system.

The use of a single winding in this coil adds surprisingly to the sensitivity of the circuit. In the first place the radio-frequency resistance of any R.F. transformer is, to a great extent, directly regulated by the amount of wire which it is necessary to use in the construction of the inductance. In the "Moore-Daniels" coil the single winding contains less than half the wire which would be necessary for the conventional three-winding coil.

Another even more important point is the mutual effect of the various currents which exist in such a coupler. The ordinarily-used three-winding coil contains a primary, a secondary, and a tertiary or tickler winding. Currents in any of these coils induce currents of opposite polarity in both the other windings. Since the purpose of the primary and tickler coils is to induce currents having the same polarity in the secondary, they must of necessity induce currents in *each other* which are 180 degrees out of phase with the initial current and, consequently, if the primary and tickler coils

are placed in the proper position with respect to the secondary, the coupling between them must of necessity be close since they will both be at the low end of the secondary. This means that the current necessarily passing through the tickler will have the effect of reducing the operating current in the primary.

Consequently we have the phenomenon (familiar to almost every builder of radio sets at one time or another) of having an increase in regeneration apparently *reduce the signal at times* instead of increasing it, while manifesting plenty of the usual tendency to throw the tube into oscillation. When only one winding is used, and regeneration is accomplished as it is in this circuit, it will be noticed that the same position of the coil is used for both the feedback and the plate coupling from the radio-frequency tube, and the objectionable coupling effect found in the three-coil transformer will be completely avoided; while surprising results may be obtained under the most adverse conditions.

The over-all sensitivity of the receiver is greatly aided by the proper use of by-pass condensers. Each of the return leads to the battery (or power supply) contains an efficient radio-frequency choke coil with the high-potential end connected to the ground by a substantial capacity; so that all of the minute variations in signal current are confined to portions of the receiver in which they are useful and not permitted to stray into other circuits where they would produce distortion of the wave form.

The by-pass condensers selected for this circuit were chosen particularly because of their extremely low radio-frequency losses and minimum "phase-angle" displacement. The losses found in mica condensers of the usual variety materially reduce the selectivity of the receiver, and ordinary paper condensers

*See an article in "Radio Broadcast" for October, 1928, by the writer, also the "Aero 1929 green Handbook."

proved totally inadequate to get proper results.

Value of Double Control

Since the antenna coupling coil is so dissimilar in construction to the other two coils, it was found undesirable to gang all three of the tuning condensers. It can be done, and with very successful results; but great skill in balancing is necessary and, as simplicity is the keynote of the design, it was thought much better to provide a separate dial for tuning the input to the receiver. A midget of very small capacity (which is mounted at the extreme right-hand side of the panel) is available for correcting any slight difference which occurs between the second and third tuning condensers; these are controlled by a common dial. Attention is drawn at this point to the fact that the rotors of both the tuning condensers are at high R.F. potential and, consequently, condensers having as little unnecessary material as possible must be used, and, in ganging them, an insulating coupling must be employed. Both sides of the condenser used to control regeneration are also at high potential; so that any possible tendency toward "body capacity" is to be remedied by mounting this condenser slightly back of the panel and controlling it through an insulating coupling.

The unusual high radio-frequency gain which this careful design makes possible has led the designers to the use of semi-power tubes (such as the '12A) for both the second R.F. stage and the detector, in order to prevent any possibility of overloading.

As previously mentioned at the beginning of this article, we find in this circuit the best features of almost every popular circuit of the past, combined with modern refinements, apparatus, and tuning equipment. The designers have taken elements from the "Betts," "National," "Chronophase," "Neutrodyne," "Everyman," and other successful circuits, and, in an outstanding application of some of the best work of DeForest, Armstrong, Hazeltine, Millen, and many more, have produced an ideal receiver for present conditions.

The audio system utilized makes possible, through a clever combination of resistances and resonated transformer

Picture diagram showing the layout of the parts for the 5-tube "T.R.F." receiver described elsewhere. The Clough audio system variously termed the "resonated primary," and the "parallel plate feed," is used in this set.

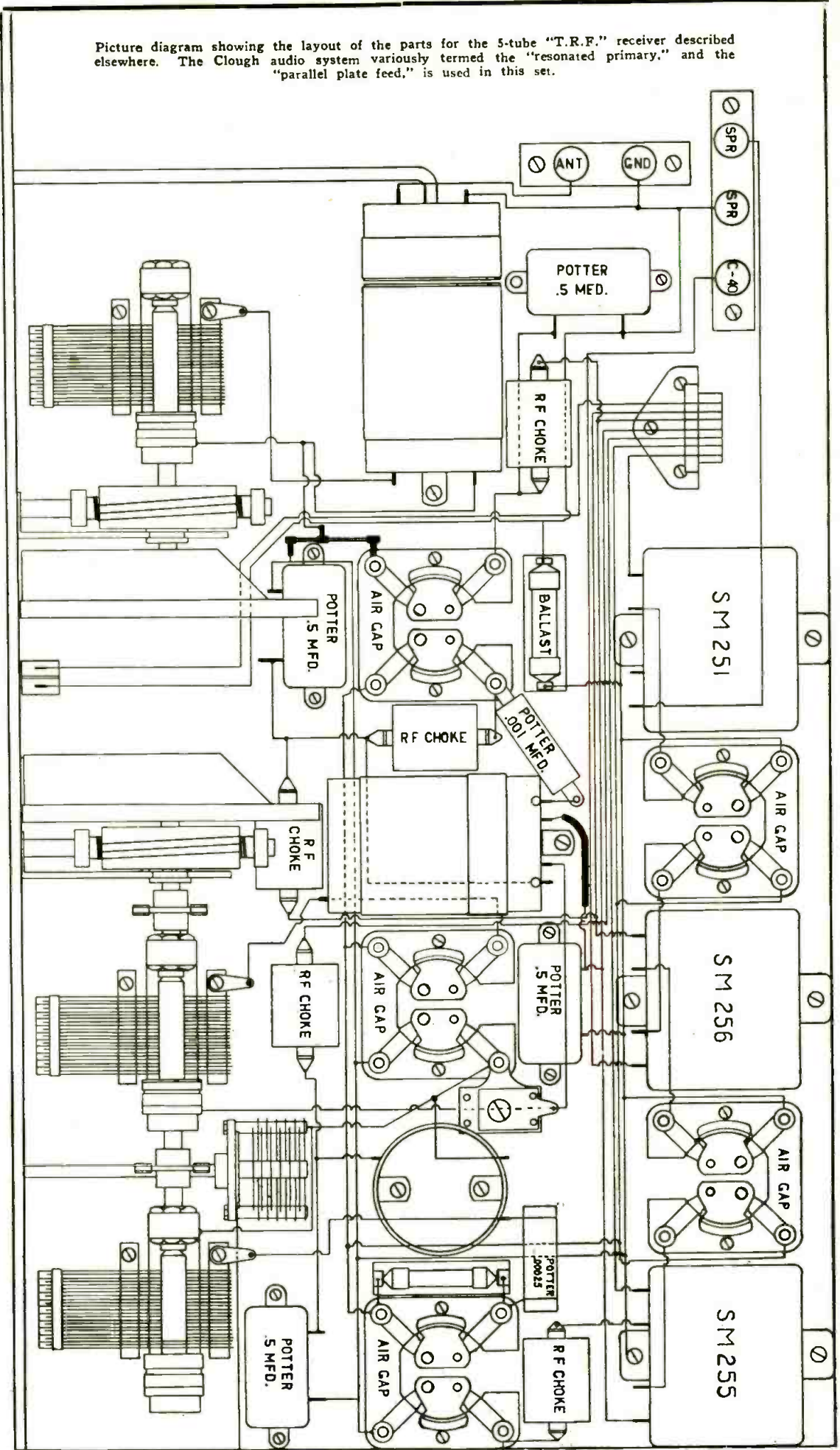

coupling, an almost perfectly flat reproduction curve over all of the audio frequencies, at a cost surprisingly lower than any other method. The completed receiver, while extremely simple to con-

struct and low in cost, will prove a revelation to its builders, unless they have (which I doubt) already handled a set as sensitive as this one.

(Continued on page 93)

Cone Diaphragms and Sector Diaphragms

The Sector Diaphragm Reproducer has made its appearance on the German and English markets in this article. Dr. Eugen Nesper shows how and why this form of diaphragm is desirable in comparison with older types of sound producing mediums.

By DR. EUGEN NESPER (Berlin)

AS loud speakers for radio reproduction, especially when it is a matter of reproduction in small or medium rooms, four different types are chiefly in question: (1), the exponential tube or horn loud speaker; (2), the loud speaker with a large diaphragm, the operating system being so far as possible without mechanical or magnetic load; (3), the electrostatic loud speaker, essentially according to the Vogt oscillating system; and (4), the electrodynamic loud speaker.

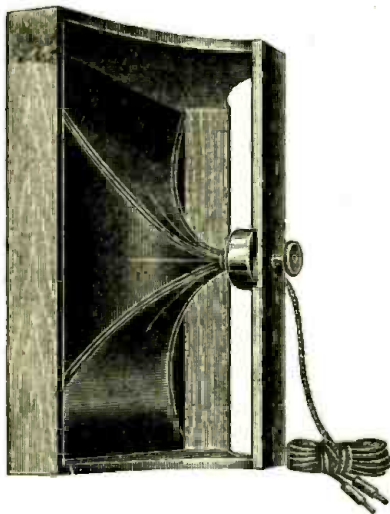

Fig. 3. Sector reproducer.

Reproduction Curves

The extremely common use of a diaphragm with a large surface has resulted chiefly for the reason that it is possible in this way, by relatively simple and cheap means, to transform into acoustic vibrations (in what is comparatively the most rational and favorable manner) the amounts of electrical energy which are provided by the usual radio receivers with average audio amplification. Actually, the curves taken of sound pressure created in such loud speakers show a relatively uniform curve from the low to the high frequencies. With good arrangement it is not especially difficult to cover the field ranging from about 100 to about 6,500 vibrations. In this field the amplitudes are reproduced very accurately.

Naturally in the course of the curve the formation of certain faults or "humps" is found (varying according to the construction of the loud speaker), but in general they are not very noticeable to the ear. To be sure, with relatively simple arrangements of this kind we can bring out neither the extremely low nor the extremely high tone frequencies, for which reason sounds characteristic of many musical instruments and also of speech cannot be reproduced at all or else only rather unfavorably.

The form most used thus far of all the large diaphragms is the cone, because it

is comparatively simple and cheap to manufacture, likewise because in it the inclusion of the operating mechanism is easily arranged.

To obtain an unobjectionable radiation of sound, the conical diaphragm must operate like a piston. If this is not the case, there is the danger of more or less evident distortion, an emphasis at resonance points. The fundamental requirement is to give such dimensions to the diaphragm that it always operates in the audio frequency ranges which lie below or above the natural frequency. This is also the reason why in electrodynamic loud speakers the diaphragm is chosen so small, since otherwise the high frequencies could not be brought out as well as they are.

The necessity of the piston-like action is the harder to fulfill in a system with electromagnetic operation, the less the motor unit is freed from mechanical and magnetic load. With a unit giving comparatively weak impulses of motion, the armature of which is likewise not completely unloaded and therefore still has a certain relay tension, piston-like movements of the diaphragm can occur only in an extremely slight degree.

Then instances very easily occur, two of which are reproduced in Fig. 1. The diaphragm begins to vibrate on itself,

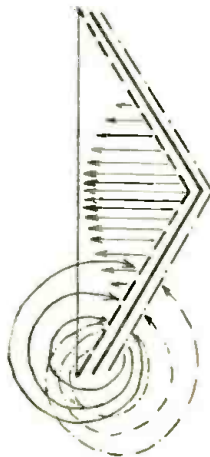

Fig. 2. Occurrence of whirl formations in the freely vibrating conical diaphragm. A baffle is an aid in the reduction of the whirl effect. It is seen that not all the diaphragm motion is directly productive of sound.

while on the surface of the diaphragm so-called Chladni figures are formed. In Fig. 1a. is reproduced the appearance of the vibration in the fundamental frequency of the diaphragm, while in Fig. 1b. the formation of a harmonic is shown. Through such vibrations the effect of tone radiation is unfavorably influenced according to the shape, material, and method of stimulus of the diaphragm, and on this very basis one cannot reckon beforehand on attaining an accurate reproduction in sound waves of the electrical energy conducted to the driving unit.

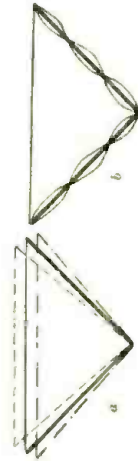

Fig. 1. Undesirable forms of vibration of the conical diaphragm. These tend to accentuate reproduction of frequencies close to the fundamental of the vibrating system, (a) being the fundamental and (b) its harmonics.

One can form an image of the vibration phenomena occurring in this, if one examines a rope stretched between two points or a taut violin string. This arrangement, if excited below its natural frequency, operates in its fundamental vibration. In every other case more or less pronounced harmonious vibrations occur.

Motional Characteristics

There is also however another phenomenon which can considerably distort good reproduction, especially in a strongly excited conical diaphragm.

This phenomenon is indicated in Fig. 2. In this case it is assumed that the surface of the diaphragm does not show any natural vibrations but on the other hand that it operates like a piston, according to the theoretical demands. The high tone frequencies are radiated substantially forward and backward from the centre of the diaphragm. The radiation of the low frequencies now occurs not purely axially forward and backward, but takes place in part more or less inclined, about the edge of the diaphragm, so that the curve shown in Fig. 2 results. Consequently the effect is produced that through the vibrations bent about the circumference, the diaphragm moving back and forth like a piston exercises a certain whirling motion; in consequence a damping takes place, through which the reproduction is impaired because of the interference formed.

This is the reason why high power loud speakers, in which the conical diaphragm (in accordance with theoretical demands) moves like a piston, are fastened in a sounding box or baffle by means of elastic non-resonant material. By this means a large part of these forms of distortion can be eliminated, yet the diagrams of sound pressure taken in such loud speakers lack uniformity.

If one secures the diagram exactly, there appear almost always in conical diaphragms built in wooden boxes of average construction, three noticeable resonance faults. The one most often occurring results from the natural frequency of the wooden box; the second resonance fault results from the natural frequency of the cone diaphragm; while the third is produced by the driving unit. By means of an especially skillful arrangement it is possible to smooth out either one or more of these faults; on the other hand, if the relations are unfavorable, the case may arise that these overlap and that then the reproduction by such a loud speaker is especially painful.

The Sector Reproducer

The *sector* diaphragm reproducer provides a very good solution of this problem. It consists of either four or six individual sectors which are mounted as in Fig. 3 in a frame in such a way that the forward edges of the sectors are mounted flexibly. The points of the four (or six) sectors are firmly joined and are fastened to the unit's driving rod.

If this arrangement was set to vibrating by the motor unit, the individual sectors would bend rhythmically, and at the same time the seams in which the sectors are joined would expand and contract rhythmically.

Now the trick has been used of joining the sectors at these seams with a flexible

elastic material. By this arrangement every point of the surface of the sectors can vibrate freely within certain limits.

It is possible that in spite of the maintaining of the necessary mechanical firmness, the surface of the sector diaphragm (like a rope fastened at one end and caused to vibrate by the hand) forms greater or less amplitudes according to the spot in question. In Fig. 4 are shown different forms of vibration in the sector diaphragm. When viewed from the vibrator of the driving mechanism, the amplitudes of motion increase constantly toward the middle, to flatten out again toward the flexible edge.

These vibration relations are present as long as the sector diaphragm representing a free form is excited below its natural frequency. For all higher frequencies there appear on the surface of the diaphragm, forms of vibration similar to those which may be seen in a rope fastened at one end and set to vibrating by the hand at the other; according to the sort of stimulus, harmonics are formed on the rope. For the sector diaphragm these vibration processes are shown in Fig. 4. At the same time it is especially noteworthy that in contrast with most fairly rigid cone diaphragms these vibratory phenomena in the almost freely moving sector diaphragm not only do no harm but on the contrary are even necessary for the radiation of sound.

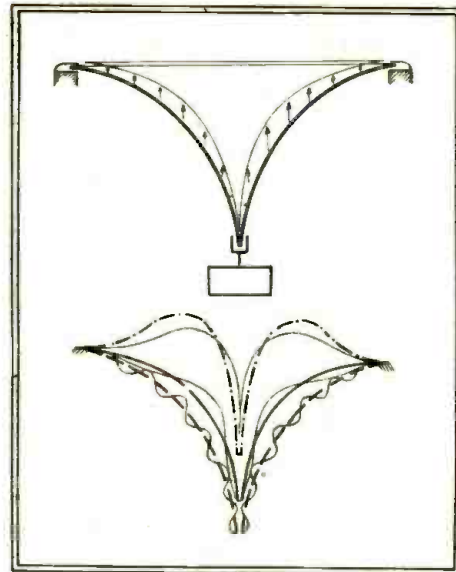

Fig. 4. Forms of vibration in the sector diaphragm. Every portion of the system can vibrate in any direction, within the mechanical design limits.

The effect of this arrangement is notably a powerful radiation of sound but above all, sound radiation (without resonance faults) in the great range from about 60 vibrations to about 8,500 vibrations, presupposing of course that the receiver or amplifier is faultless and not overloaded.

A Type '45 Tube, Push-pull, Power Amplifier Circuit

A TYPE '45 amplifier circuit recommended by Amertran, and the most recent amplifier developed in the Amertran Laboratories (Newark), is shown. The instrument designations are as follows:

- T1, first stage DeLuxe, or other input A. F. T.
- T2, 151 input A. F. T.
- T3, 442 output A. F. T., for magnetic reproducers, or 443 output A. F. T., for dynamic reproducers.
- T4, 245 power transformer.
- L1, 256 audio choke.
- L2, 641, preferably, or 988, or two to three 256 audio chokes.
- L3, 854 choke filter.
- L4, 709 choke filter.
- R1, stabilizing resistor, 50,000 ohms (3 watts).
- R2, "C" bias resistor, 2,000 ohms ('27 tube).
- R3, stabilizing resistor, 50,000 ohms (or less).
- R4, R500 voltage divider, 31,000 ohms.
- R5, detector plate resistor, 100,000 ohms.
- R6, "C" bias resistor, 850 ohms ('45 tubes).
- R7, R8, R9, center tap resistors, 10 to 30 ohms.
- G1, meter jack, '27 grid current.
- P1, meter jack, '27 plate current.
- G2, meter jack, '45 grid current.
- P2, meter jack, '45 plate current.
- P3, meter jack, total current output.

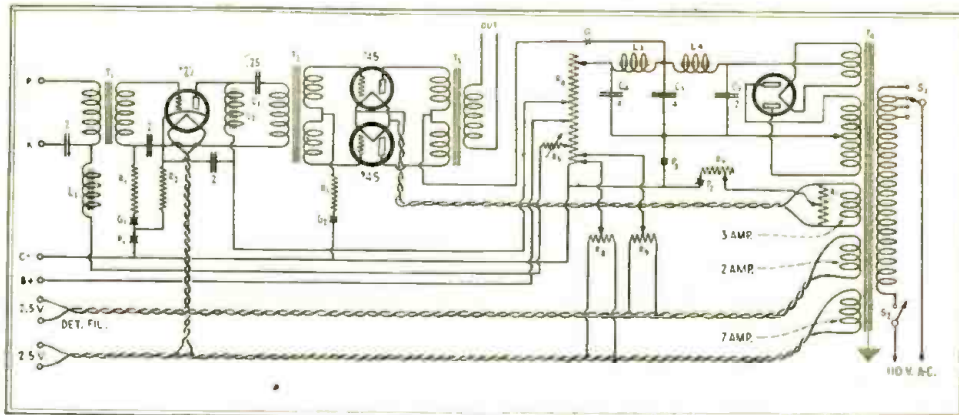

The "last word" in power amplifier design: incorporating all-A.C. operation; type '27 first stage audio; parallel-plate-feed first stage-to-second stage coupling; push-pull type '45 tubes; provision to supply "A," "B" and "C" potentials to a separate detector and radio frequency amplifier unit; and connections for dynamic reproducer field winding.

- C1, parallel plate feed condenser, 0.25 mf., working voltage 400 (rating).
- C2, filter condenser, 2.0 mf., working voltage 600 (rating).
- C3, C4, filter condensers, 4.0 mf., working voltage 600 (rating).
- S1, tap switch, 4-point (H. & H. No. 1671).
- S2, on-off switch.

may be used as T1, to operate in conjunction with phonograph pick-ups.

Audio transformer T1 must be placed with exceptional care with regard to its inductive relation to power transformer T4 and power chokes L3 and L4.

K connects to the cathode terminal of the type '27 detector tube in the R. F. chassis of any A. C. radio set. For battery operation, C— would connect to the "B" minus post of the R. F.-and-detector chassis, and K would connect to "B" minus also. It may be advisable to fuse the 110-volt line.

A type '80 full wave rectifier supplies the correct amount of current.

If the type '45 tubes are gassy, that is, not sufficiently freed of gases, resistor R3 may be omitted and a 709 choke inserted at (a).

A transformer having the correct design for the particular pick-up selected

How to Build a Giant Free-Edge Cone Reproducer

Being the constructional data for a loud-speaker assembly capable of developing high volume from low power output.

By LOUIS GANCHER*

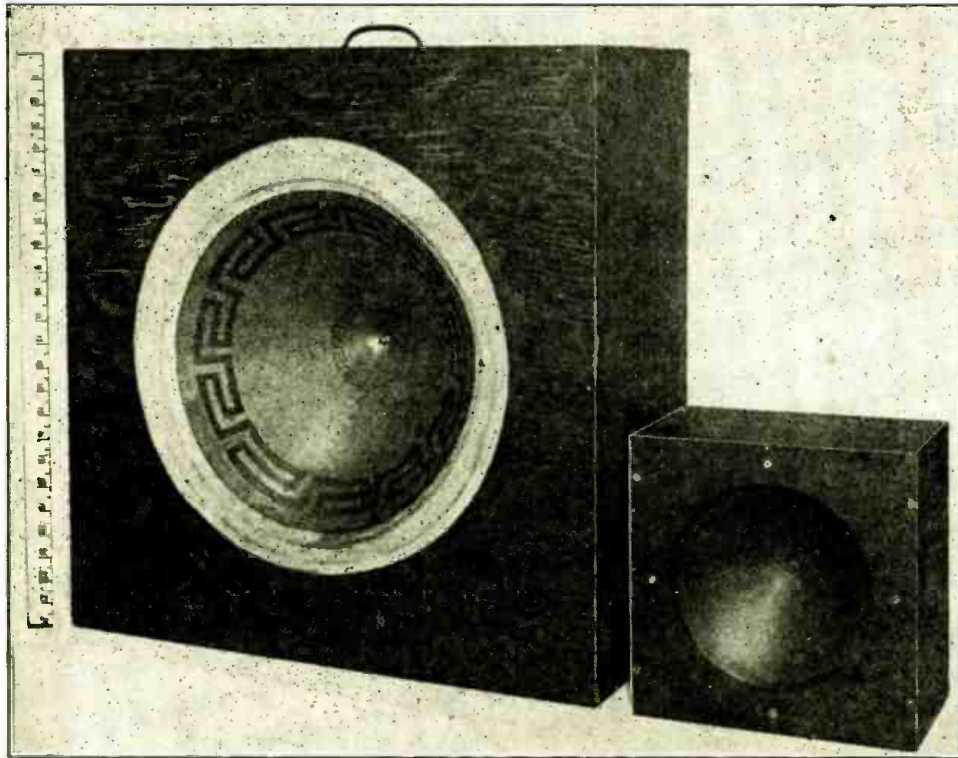

Flexible suspension of the small cone was borrowed from dynamic speaker practice, chamois being the material used.

By making the baffle of a certain shape (in order to enclose a certain amount of air) it was possible to obtain audio reinforcement at the correct point. As the characteristics of reproducer units vary, it is desirable to have some compensation; and this is obtainable in the Giant power instrument by varying the number or width of boards across the back of the cabinet.

Photograph of the 14-inch cone reproducer and a standard cone reproducer. The "motor" or driving unit is a vital factor for successful results. It seems that foremost radio set manufacturers are seriously considering the use of cones of increasingly large dimensions, at least one commercial receiver for 1929-1930 including a dynamic reproducer with a 14-inch cone!

THE subject of radio reproducers is an extremely delicate one about which to speak, in these days of varying opinion on subjects acoustic. There are those who believe the large paper diaphragm is the best form of cone construction; given the proper motor unit and other conditions. This form of construction was very popular at one time, as it seemed to be the most convenient way of reproducing the lower-register notes with the necessary fidelity.

Of course, one could always build a horn of the exponential type and, if it had an air column of such-and-such a length and an opening of such-and-such a diameter, the "cut-off" frequency would be at a certain number of cycles.

The difficulties of home-constructing a really satisfactory one may be better realized when it is recalled that the horn speaker which won the Franklin Institute prize for reproductive accuracy had a length of 13 feet. The wall was one inch thick. One ton of iron was used to cast it. The reason for this enormously massive design was the elimination of resonant points within the operating audio spectrum. This result is obtained in the laboratory by the use of sheet lead about one-quarter inch thick.

The modern small cone, familiar to all, is a gesture in the opposite direction. This reproducer is of entirely different construction. It is very light in weight; it is exceedingly compact; it is

easy to make artistic in appearance; it is readily placed almost anywhere.

This comment might just as well apply to the dynamic type of construction. However, the dynamic reproducer has two outstanding advantages; (a), it reproduces bass notes with greater volume than the small magnetic-type cones; (b), it will stand a greater signal input without distorting badly.

Although it is generally agreed that a magnetic-type speaker, properly constructed, is very natural in its reproduction, the agreement does not extend to the power-handling ability of the dynamic and magnetic on a par basis. For extremes of power, a dynamic speaker is more satisfactory.

The average magnetic speaker compares with the dynamic only at low volumes. When the power is increased, low notes are reproduced much better by the dynamics.

To overcome this condition, the reproducer herein described was designed. It incorporates features of the three-foot cone, the exponential horn, the small cone, the dynamic reproducer and the low note baffle.

The special paper (Alhambra Fonotex, generally used on the three-foot speakers) was found to be the best material for correctly developing the flexural and piston motions of the diaphragm. (In reality there are not two, but five diaphragm motions.)

The driving unit is one that proved very effective on airplane cloth speakers of the better type (the "BBL" unit).

Some recent experiments with Celotex, Prestwood, Masonite, balsa wood, beaver board and several of the more ordinary woods gave very interesting results and the experimenter will do well to try some of the combinations which occur to him. It seems that the resonant characteristics of some of the harder woods result in a more pleasing tone than is obtainable with non-resonant materials, at the low frequency end of the audio scale. With non-resonant materials for the baffle-cabinet, the middle and high register notes sound a little more natural, a little more "ringy." The thinner the boards are, the more resonance results.

The average diaphragm diameter of dynamic speakers (and most free-edge magnetic-type cone speakers) is about eight inches—the Giant reproducer diaphragm has a diameter of 14 inches!

Assembly Instructions

The first thing to do is to mark the "parchment." A simple way to do this is to drill two small holes in a thin wood strip or bar. The holes are to be nine inches apart. Put a nail through one hole and the parchment. Put a pencil in the other and scribe a circle which will have a diameter of 18 inches. On the circle drawn, make two marks 14 inches apart. Scribe one radial line from the center to each of the marks on the circle. This makes a "pie" shaped segment which is to be cut out.

With the Grain!

One of the two long edges of the segment must parallel the grain of the paper. By bending the paper it will be found to roll quite easily in one direction and from one side. This is the direction to work from.

Also, cut around the circle, removing the excess paper. (In the earlier three-foot speaker design it was usual to have

*Chief Engineer, Radio Specialty Co., N. Y. C.

a half-inch flap all around the circle. This is not needed in the new design.)

Cut out a quarter-inch circle at the center of the circle (the apex of the "pie"). It is usually most convenient to do this with a razor blade, as the cut should be clean and not ragged.

Mark a half-inch flap along one edge of the pie; on this flap apply a thin coat of the cellulose cement made for this purpose—or "tacky" glue may be used, although it takes considerably longer to harden.

When the cement has become tacky, draw the two edges of the segment together and hold them until the overlapping flap has become securely fastened to the opposite edge of the segment.

Now, the apex may be inserted and fastened. It will be seen that the portion of the parchment removed has made room for the metal of the apex. Of course, the apex locking-screw must go on the outside of the cone.

A good clutch type of apex will probably be much better. The reason for this is that the bore of the lock-screw apex is not a perfect fit for the drive-pins of motor units. The result is a rattle at certain powers and frequencies, due to the "side-swipe" of the drive pin. This effect is unlikely to occur in the clutch-type apex, if it is well made.

The Chamois Ring

Although the front of the reproducer is shown without a covering, constructors usually place a piece of tapestry over the entire front. In fact, the tapestry may serve the dual purpose of a decorative front and flexible cone anchor. In this instance the chamois is not used, the cone being glued directly to the tapestry. The sound will come through the tapestry and it will be unnecessary to cut a hole in the material for this purpose.

Otherwise, the chamois is glued to the front of the cabinet, to a width of about one-quarter inch. Then, glue is applied to the extreme edge of the cone, the cone is centered in the opening of the cabinet and pressed down tightly against the chamois (or tapestry) and held there until thoroughly dry. Not until then is the final coat of cement or glue applied around the edge of the cone, where it meets the chamois, further to anchor it. Any carelessness in the work up to this point will result in the production of rattles, very difficult to localize and perhaps more difficult to remedy.

The tapestry may be an integral part of the acoustic system or, perhaps, merely an artistic finish. In either case, it is desirable to glue the material to the cabinet at opposite edges, pulling reasonably tight and even. When the glue has set, the two sides can be pulled to position and glued. This removes the wrinkles in the cloth.

Mounting the Unit

The next step is to mount the driving or "motor" unit. It is screwed to the center of the back bar that spans the sides of the cabinet's rear. Connect the unit to the radio set and turn the power to "full." Move the bar around, a fraction of an inch at a time, until the drive-pin, which has been placed in the apex, rattles freely. If it will not do this, the

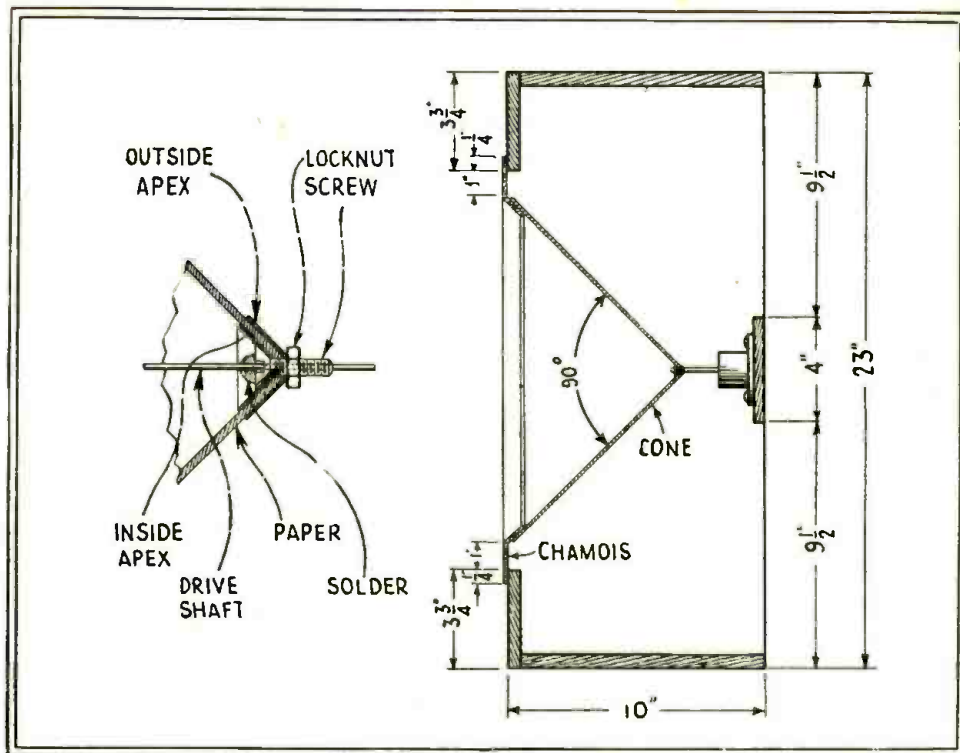

Detailed drawing of the 14-inch cone reproducer; and also a detail of an apex which does not permit "rattles" to develop.

apex is too small or the drive-pin is too large,—the effect is the same either way. The remedy is, usually, to change the apex; but, occasionally, it may be necessary to get a smaller drive-pin.

The pin must be located in a direct line from the unit to the apex. If there is any wobble evident in the rod, there assuredly will be distortion.

Having located the exact position for the unit, the cross-bar is marked and drilled for round-head screws. Large washers are used with these screws, and the holes in the wood are made several sizes too large. This permits a final adjustment of the unit bar, to take care of slight warpage as the screws are pulled up tight.

Nails may be used to fasten the cabinet but flat-head wood screws are recommended, and these should be pulled up as tight as a large screwdriver will fasten them.

After the unit bar has been securely fastened, the apex may be tightened. If an aluminum apex is used, it will be necessary to acquire a certain "feel" of the tightness; as too great a twist will shear the metal and too slight a twist will allow the drive pin to "wobble" slightly.

The builder who wants something a little bit better than average will be glad to construct the special apex pictured. It is made by drilling through the full length of a flat head machine screw, with a drill the size of which is a slip fit for the particular drive shaft used. An apex cup is placed on the screw and the two pieces assume the position shown, an outer apex following, all to be locked up quite tight by means of the locknut. This makes a very rigid apex assembly. The final operation is to accurately align the drive pin, as outlined above, and to solder the pin to the head of the screw. If a brass screw is used, this will be a little easier to do than it would be if an iron screw is used, although the latter can be soldered when an acid flux

is used. Care must be taken to prevent damage to the cone, due to the heat of the soldering iron.

The finish of the cabinet is optional. In fact, an unusually fine piece of furniture may be developed from the general design furnished above. In many instances the constructor will prefer to extend the two sides of the cabinet and fashion them in some simple manner. The result is both pleasing in appearance and practical, as a book shelf-radio reproducer is the result.

It must be mentioned that this speaker combination will not rattle on considerable volume, and bass notes will be reproduced with fidelity if the proper adjustment of the motor-unit gap has been obtained. However, rattles and generally poor operation will result if the unit has been permitted to vary from the correct position during assembly, or if the two (or four) air gaps are improperly spaced with relation to the armature. The latter condition can be checked before the unit is purchased, a close inspection being sufficient.

There are many other elements which enter into the production of "timbre." For instance, substituting canvas or leather for the chamois ring will change the quality of the reproduction. Also, using tapestry instead of chamois will result in a different "tone." Various diaphragm materials will cause a change in the reproduction. One-inch stock is recommended for the baffle cabinet; if thinner material is used, it will evidence resonance characteristics (which may be preferred by some constructors).

A control of the "timbre" of the reproduction of certain portions of the scale is made possible by closing the rear of the cabinet to a greater or lesser degree. This may be done as a permanent form of construction (the proportion of the opening being determined by the characteristics of the particular audio amplifier and unit combination used) or it may be made to be variable.

Home Talkies With Your Radio

A perfectly developed instrument, the Home Talkie unit, has been devised to span the gap between the home movie and the home radio. The result is "talking motion pictures" at home.

By A. PAM BLUMENTHAL*

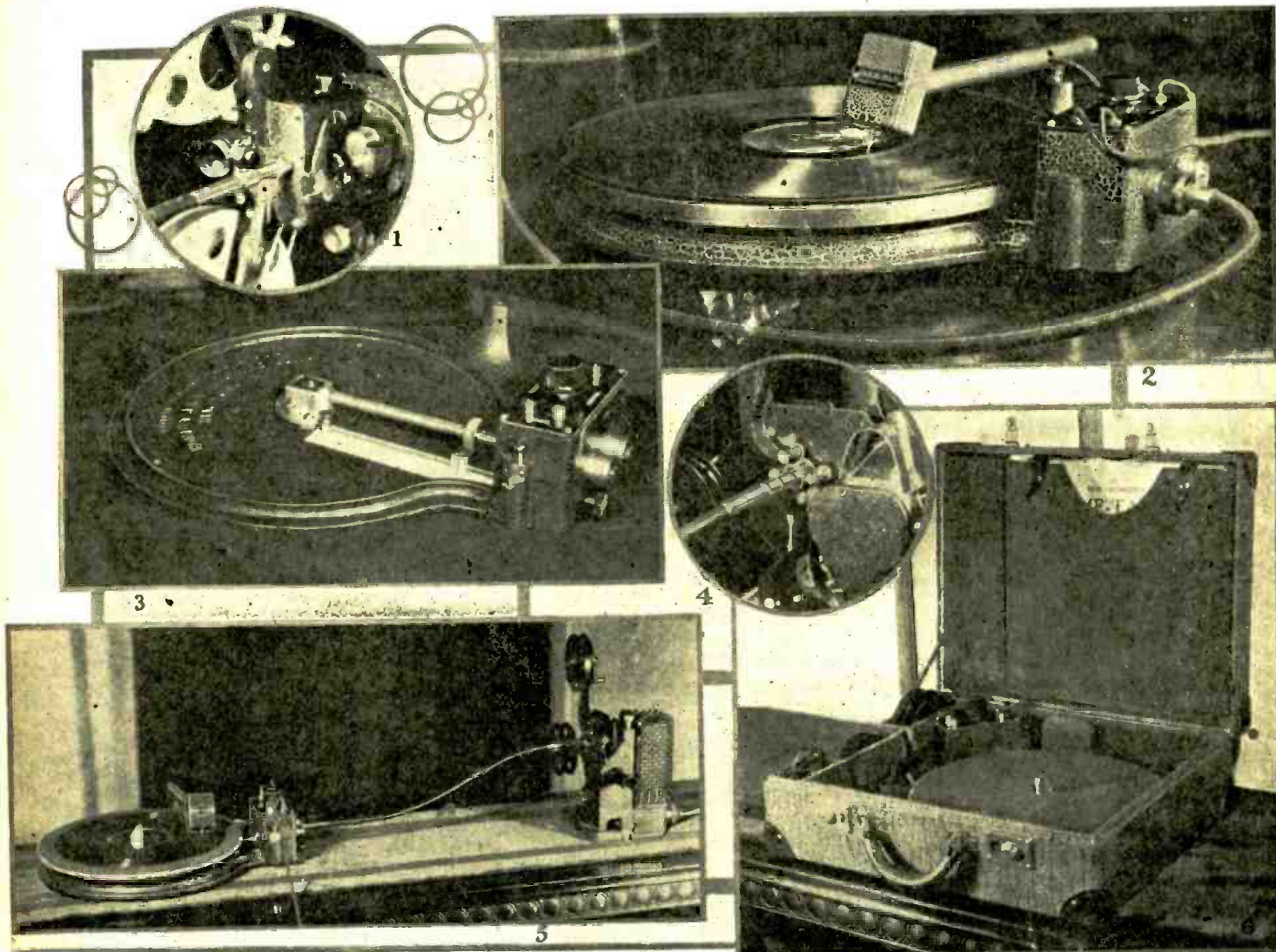

The illustration above includes the following views: Fig. 1, Bell and Howell motion picture projector with Home Talkie driving cable attached; Fig. 2, Home Talkie unit showing where the two leads from the detector tube socket of the radio set plug into phonograph pick-up tip-jacks on the top plate of the gear box; Fig. 3, Same unit without turn-table, showing driving rod, vernier adjustment knob and shaft, bevel face pointer, and rotation-ratio scale; Fig. 4, Kodascope projector, Model C, indicating point from which turn-table drive is taken; Fig. 5, Proper placement of a Home Talkie unit in relation to a picture projector (the "Kodascope" is illustrated); Fig. 6, Demonstration case for a "Home Talkie" unit and picture reels. In addition to these reels and unit, a glass bead ("Truvision") screen, collapsible on a 3-inch roller, and an all-electric power amplifier—with dynamic reproducer (in a carrying case) are obtainable for those who wish to (figuratively)—"bring the mountain to Mohammed."

THE question "Shall we, or shall we not, have talkies in the home?" is dependent upon a few fundamental considerations. Such secrecy has been observed by the various interests backing the commercial talking motion picture, that the usual reaction to the suggestion of talking motion pictures in the home would be to think in terms of the future, rather than the present, were it not that demonstrations prove they are not imaginary; that they are "here."

Enter the Home Talkie Serviceman

It may come as a surprise to many to learn that there are more than 250,000 radio set owners who also have motion-

*President, Home - Talkie Machine Corp.,

picture projectors. These people are well able to pay the bill for tying the two together. That they have not done so before this is due only to the fact that the necessary parts have not been available; no technical men have been in a position to broach the idea, although the big movie interests have paved the way.

There are two methods of audio reproduction in use at the show houses. One is *non-synchronous*. The other, the subject of this article, is far better. This is the *synchronous method*, by which the sounds may be heard at the exact instant the screen shows the corresponding action.

One photograph shows a complete assembly of this type and the drawings and additional photographs show the "how."

A complete installation includes a motion-picture screen, a picture projector, a synchronized record for same, a record turntable driven by the motor of the picture projector, and a phonograph pick-up with its connection plug for the regular radio set. With this equipment in operation, the appropriate sounds are heard from the radio reproducer as the picture unfolds.

(For those who are not "in the know," a standard 16-millimeter film has a length of 200 feet and a "home talkie show" requires five minutes and thirty-seven seconds. A "Truvision" beaded glass screen is probably the most perfect "silver screen" obtainable for home use, having 30% to 50% greater "definition" than plain cloth screens.)

Construction Details

There are many little structural features about the main machinery, the turntable components, which are of interest.

For instance, experimenters have found that the vibration generated by the projector and the "whip" of intermediate gearing is transferred to the pick-up, and the result is distorted reproduction. By inserting in the gear box a "ripple killer" (a heavy spring between the drive shaft and the gearing), ripples are ironed out.

Also, much difficulty has been experienced in the past by turntable wobble and rock. By mounting the turntable off center it is possible to tip it up and off the rubber-tired drive wheel, to make adjustments. This prevents wear at one point on the wheel, a cause of bumpy rotation. The off-center mounting also makes it possible to maintain an even pressure on the wheel by gravity. In addition, the weight of the pick-up is placed directly in line with the wheel and the center pin so that, no matter how much the turntable may rock elsewhere, it is always firm on this line.

To obtain 100% synchronism, a flexible four-layer spring shafting, fabric-encased, is run directly from the projector to the turntable gear box. The instant the projector moves, the turntable must respond.

Every projector has some part which turns in relation to the film mechanism. It is necessary only to couple a shaft at this point, usually the main feed sprocket, and properly gear the shaft to the turntable. Coupling units are illustrated. The "end" that fits the Kodascope Model C also fits the Victor. The Filmo "end" also fits the Model A Kodascope. On the Filmo this end is inserted in the hollow protruding knob on the front used for advancing single pictures by hand. (Fig. 9f.) This same end can be inserted in the black knob that is used for single-picture advancement on the Kodascope Model A. (Fig. 9a.) The end for the Model B Kodascope (only) is claw-shaped, and fits over the "hand set" knob on the side of the shutter housing (Fig. 9b). To attach the Kodascope Model C end, remove the small knurled knob on the feed sprocket (Fig. 9c) and substitute the end. The DeVry Model G (early type) has a short extension on the sprocket shaft (Fig. 9d) to which the end fastens; the DeVry Model GRS (later type) has instead a "hand-set" knob under the mirror housing (the triangular box on the back of the "gate") which is to be removed and replaced by the end (Fig. 9e).

Synchronization

The flexible shaft (9g) should be almost straight, with only a slight dip, as pictured. At the gear box it is to be fitted into shaft socket "A" and locked with a threaded flange. (The Kodascope Model B drives the shaft in the opposite direction, and shaft socket "B" is used for correcting the rotation of this machine only, by means of a gear wheel in the gear box, as illustrated.)

The projector will rotate at one of two speeds (at the drive-shaft connection), but the turntable must run at

The Screen-Grid "Peridyne" At Last!

NO fundamental circuit has found more devoted followers among set-builders and experimenters than the "Interflex." They have hailed with enthusiasm every new development, throughout the entire series of sets which developed the original idea into its highly-perfected form, the "Peridyne," which appeared in 1927, and which represented the maximum possible efficiency with tubes then available.

No mail which the publisher has received, of late, fails to contain requests for details of adapting the "Peridyne" to screen-grid tubes. For the past few months, Mr. Hugo Gernsback has been experimenting at every available opportunity to perfect the Screen-Grid "Peridyne" hook-up; and he has finally developed a receiver of unrivalled sensitivity and power, which is worthy of being presented to the readers of RADIO-CRAFT as the climax of his radio set designs.

The new Screen-Grid "Peridyne" will be described in the September issue of RADIO-CRAFT. Watch for it!

only one speed for a given record. A lever-fork on the gear box shifts gears, as the drawing shows, in accord with these speed (r.p.m.) requirements:

Setting	Projector	Record
H	1440	33 1/3 or 78
L	180	33 1/3 or 78

The lever settings for the various projection machines are as follows: Filmo,

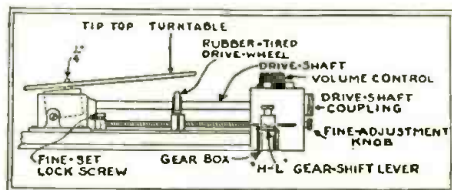

Fig. 7. Detail of the Home Talkie unit, showing means to prevent wear on the rubber drive wheel.

H; Kodascope Model A, L; Kodascope Model B, H; Kodascope Model C, L; DeVry, early models, L; DeVry, late models, H.

Home Talkie and Vitaphone synchronized records are made at 33 1/3 r.p.m.; Victor synchronized records and all

makes of non-synchronous (ordinary) records are made at 78 r.p.m. The non-synchronous or ordinary records are used when it is desired to have incidental accompaniment to non-synchronous or ordinary films. With turntable speed adjusted, as described below, the projector will run 24 "frames" per second for synchronous operation, but should be slowed to eighteen "frames" per second for non-synchronous operation ("incidental accompaniment"). Of course, the projector may be run at the latter speed without film and regular records played without pictures.)

For synchronized operation of 33 1/3-r.p.m. records, the scale-pointer is set at 45; for synchronized 78-r.p.m. records, 155; for non-synchronized 78-r.p.m. records, 180.

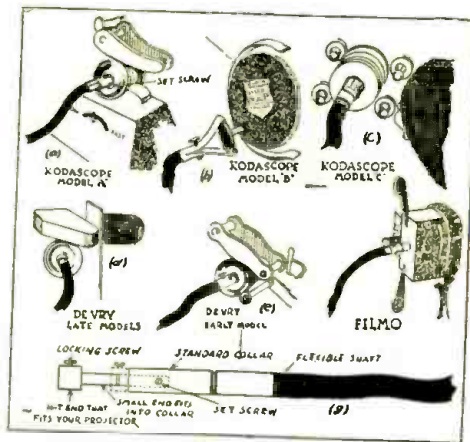

Fig. 9. Above are shown various connectors for standard picture projectors, and the proper point at which to attach these.

Adjusting Turntable Speed

The projector speed may be balanced against the turntable or vice versa. In either instance the speed of the standard must be accurately known. As it is too difficult to follow the second method, the first is used.

The record speed may be checked accurately by counting the revolutions of a piece of white paper placed between the record and the turntable. It should rotate exactly 33 1/3 times per minute (a preliminary check may be made by counting the revolutions (16 2/3) in 30 seconds) with the scale-pointer at 45. If it does not, the "vernier" knob on the front of the gear box is adjusted slightly until the scale-pointer has been racked

(Continued on page 93)

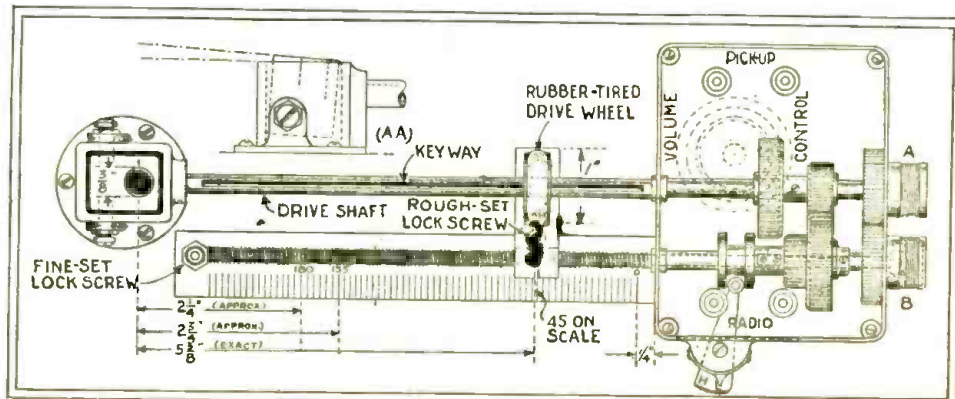
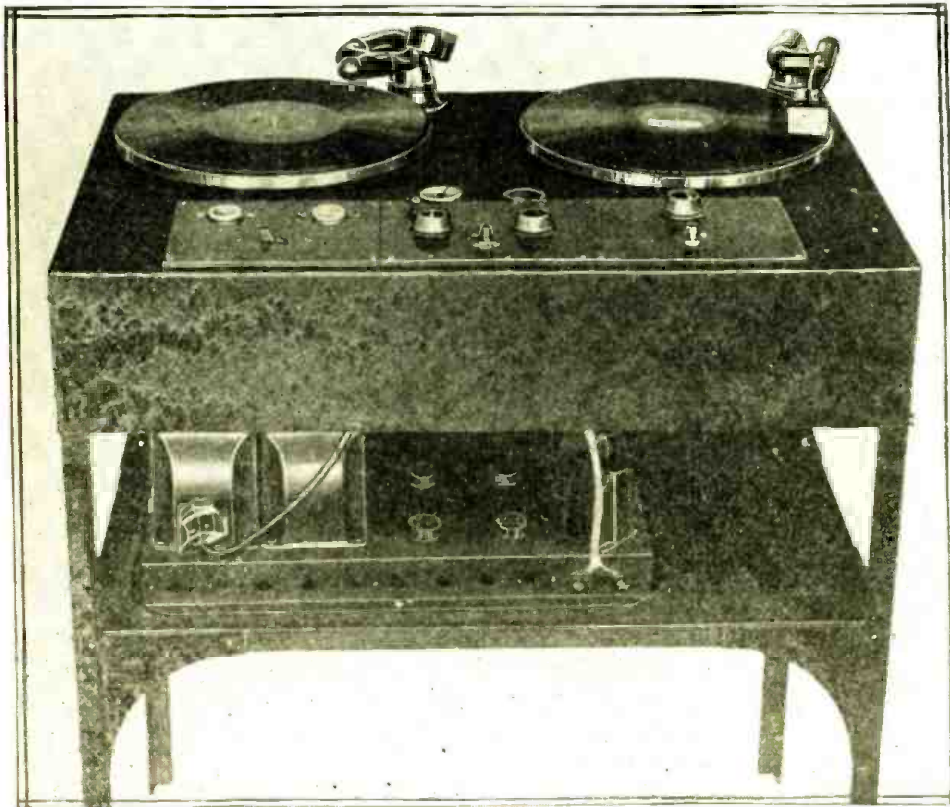

Fig. 8. How the few parts are related for turning a phonograph record so that its recording is in exact synchronism with the corresponding views from any type of motion picture projector. The volume control potentiometer resistance is shunted across the "radio" tip-jacks, the movable arm and one side of the resistance being connected to the connection points marked "pickup."

Radio Programs for Motion Picture Theatres

A radio frequency receiver, an audio frequency amplifier, a power unit, and other details of "talkies" are treated in this article.

By W. L. WOOLF*



connected across the secondary of the filament transformer, furnishing means of obtaining an electrical center tap. This center tap is then connected either to "B" minus or to "B" plus 45 volts, depending upon which of these connections gives the closest approach to humless operation.

Complete turn-table assembly. The "pack" shown was temporary. The left panel has two 110-volt, 6-amp. fuse receptacles and a 110-volt switch. The center panel has two control knobs, the left one being a volume control for an external synchronous or non-synchronous (sound effect) pickup (a microphone can be used) and the right one being a master fader for the two non-synchronous pickups illustrated; the switch is for impedance-matching the external pickup. The panel on the right contains a volume control for a monitoring reproducer and a switch for the field winding current supply of the monitor.

Binding posts 34 and 35 are connected to the input posts of the theatre amplifier, aerial and ground are connected to the tuner, the filament transformer is connected to a 110-115 volt A.C. source, correct "B" voltages are supplied to the tuner and it is then ready for operation. A turn of the knob tunes in stations, and with sufficient output for use with modern talking picture amplifiers.

CUSTOM set builders are now receiving many requests from owners of motion picture theatres for a positive-action, easily-operated, all-electric radio frequency tuner. The theatre people desire a fool-proof unit, which can be connected readily to the amplifier of the "talkie" equipment and which can be used to bring in election returns, political speeches, prize fights and other radio events of national interest, through the theatre group address speakers.

A compact single dial control radio frequency unit, consisting of three stages of tuned radio frequency and a detector using plate bend rectification, and operated direct from the light socket, has been designed.

The antenna coil is a standard R.F. transformer and the various stages are all coupled by means of matched coils. The R.F. stages and the detector are tuned by means of two sets of two-gang "battleship" variable condensers, operated by a single drum dial.

Grid suppressors 6, 13, 21 stabilize the circuit, and the small variable condensers 17 and 25 are utilized as equalizers. The various stages are shielded from each other, as indicated.

Volume is controlled by means of a resistance, shunted across the primary of the antenna coil. Grid bias is secured through the voltage drop across resistors, connected in the circuit between "B" minus and the cathode of each tube, by-passed to ground by condensers.

Circuit isolators are used at 11, 19 and 27 for the purpose of choking back R.F. currents from the "B" eliminator, these currents being by-passed to the cathodes and thence to ground by means of condensers. Quiet operation results since they produce the effect of a separate source of "B" supply for each tube.

An R.F. choke is used at 33 to block radio frequency currents from the audio amplifier. This choke is by-passed by a .001 mfd. mica condenser.

A variable 20-ohm potentiometer is

A Power Supply

In some cases, the set builder will be called upon to furnish not only the tuner, but also the "B" supply, a suitable audio amplifier and a complete group address system, including apparatus permitting a picture exhibitor to reproduce, by means of a special phonograph pick-up, music appropriate to any picture and in addition, non-musical sounds, such as those made by a moving train, bells, thunder, etc.

The suggested "B" supply and audio

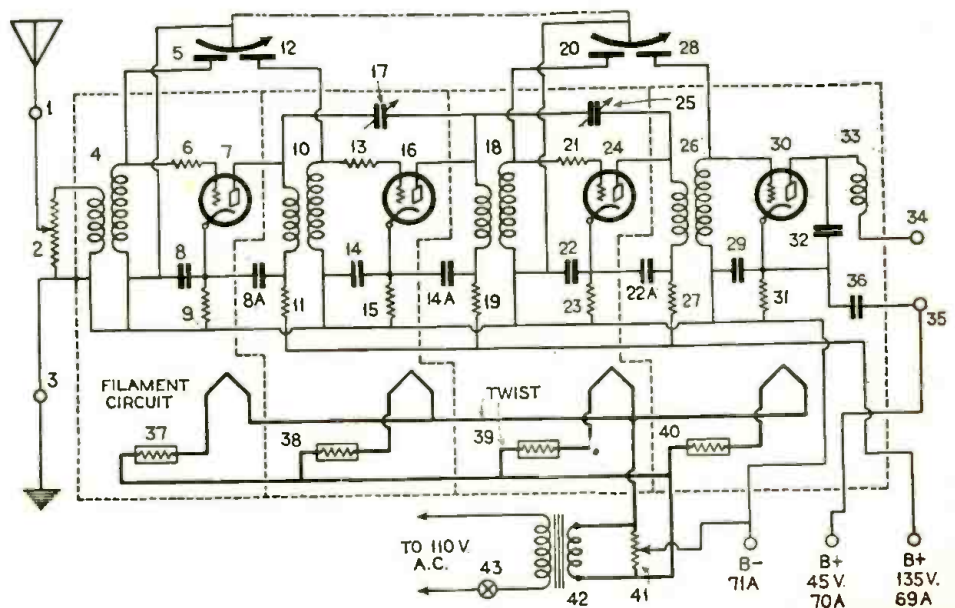

Schematic circuit of the radio frequency receiver recommended for use with "sound" equipment of moving picture houses.

*Directing Engineer, Amplion Corp

amplifier, shown in the accompanying diagram, utilizes two stages of audio amplification. The first audio stage uses a '27 tube, while the output stage uses two of the new '45 tubes in push-pull. The secondary of the output transformer is carefully matched for and should be connected *directly to the movable coil of the dynamic speaker.*

Plate voltage for all tubes, both in the amplifier and the tuner, is supplied by a power compact. This also contains the filter chokes and supplies filament current to the full wave rectifier tube and to the two power tubes. The first audio tube 49 receives its filament current from the filament supply transformer on the tuner.

Proper grid bias for the first audio tube is obtained through the voltage drop in a resistor 50. The voltage drop in the resistance 56 gives the correct grid bias for the push-pull output tubes.

In order to preserve the flat characteristics of the audio system, the circuit isolators shown at 48, 53 and 55 are desirable. A tapped unit is used to subdivide the plate voltages, as required.

The speaker recommended for use with the above equipment is a horn type dynamic unit, used with a 10-ft. exponential

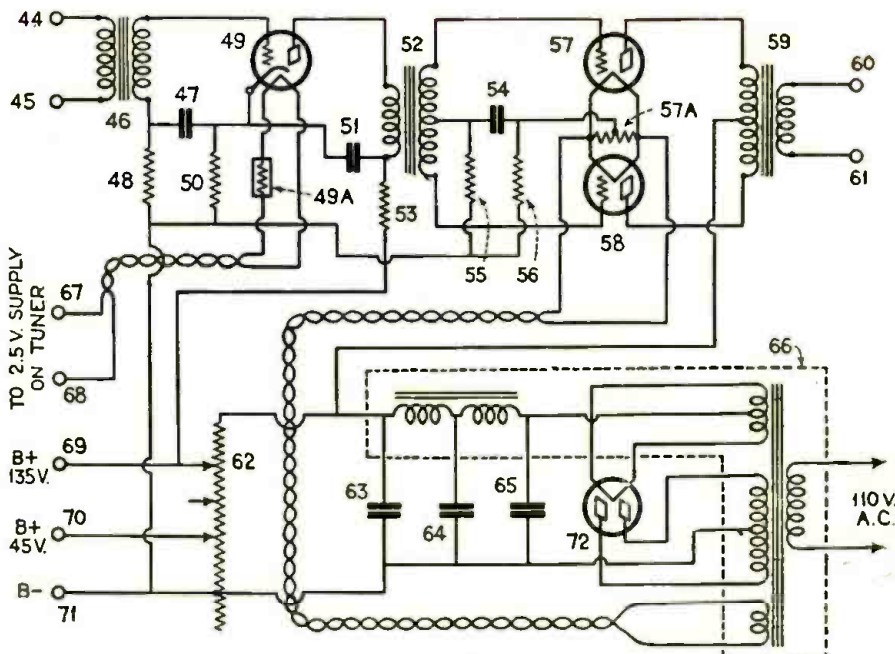

Schematic circuit of the audio amplifier and power supply necessary to complete a theatre "sound" system. This amplifier may be used with any standard radio frequency amplifier, for home use.

picture being shown. A cabinet, shown in the illustration, has been developed for this service. This cabinet contains

two electrically driven turntables, two magnetic pickups, a chronometer and a bakelite panel on which are mounted complete controls for *fading* one piece of music out and bringing another in and for tuning in special sound effects. For the reading of titles, announcements, advertisements, etc., a microphone may be cut into the circuit, by means of a handy switch, also located on the control panel. A special microphone amplifier furnishes one stage of audio frequency amplification and the direct current energy for the microphone, from 110 volt, 60 cycle, alternating current. This amplifier is designed to operate into any standard power amplifier.

As an example of the usefulness of the R.F. tuner, the theatre owner may wish to bring in through his group address system, a championship prize-fight,

(Continued on Page 86)

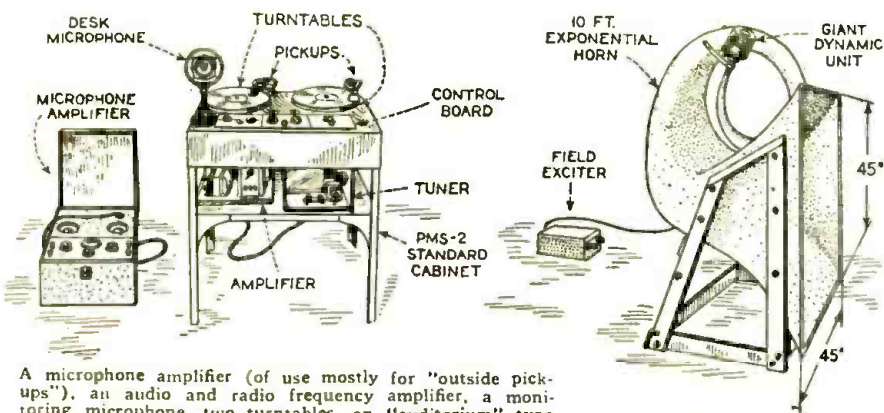

A microphone amplifier (of use mostly for "outside pickups"), an audio and radio frequency amplifier, a monitoring microphone, two turntables, an "auditorium" type horn, with dynamic unit, and the necessary controls are the items illustrated, and these constitute a standard "sound" system.

air column horn. This unit is one of the largest dynamic units made, its weight being approximately 20 pounds. In addition to theatre use, the unit is suitable for use in parks, places of amusement and in fact, any place where groups of people are gathered together. The dynamic unit is capable of handling 30 watts of undistorted power. The field supply is 1 1/4 amperes at 6 volts. The source of this supply may be either a 6-volt storage battery or a 110-volt D.C. line with a 90-ohm resistance in series, or a rectifier that will give 6 volts D.C. from 110 volts A.C. house current. In the latter case, a step-down transformer of approximately 15 to 1 ratio is required.

It is possible to obtain horns for use with this unit ranging in size from 42" long and 22" in diameter to horns having an air column 15 ft. long with a bell 54" square and weighing 55 pounds. The one specified in the present instance is a 10 ft. exponential horn, having a bell 45" by 45".

The motion picture theatre exhibitor installing this R.F. unit should also install apparatus permitting the playing of music and sounds appropriate to the

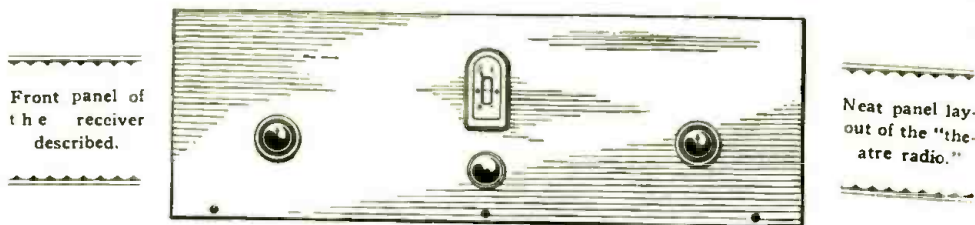

Front panel of the receiver described.

Neat panel layout of the "theatre radio."

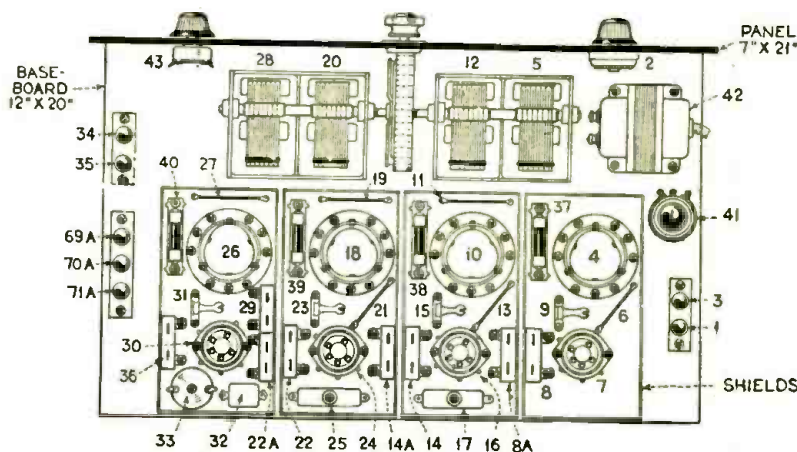

Layout of parts for the radio frequency receiver designed for use in conjunction with existent audio amplifiers operating in theatres, halls, or other large gathering places.

SHORT WAVE CRAFT

A Complete Portable Transmitter and Receiver

In this article, Mr. Lawrence B. Robbins, W-1 A F Q, describes in detail how to build a complete radio transmitting and receiving set operating on the short waves. We will welcome reports of results obtained by builders of this portable.

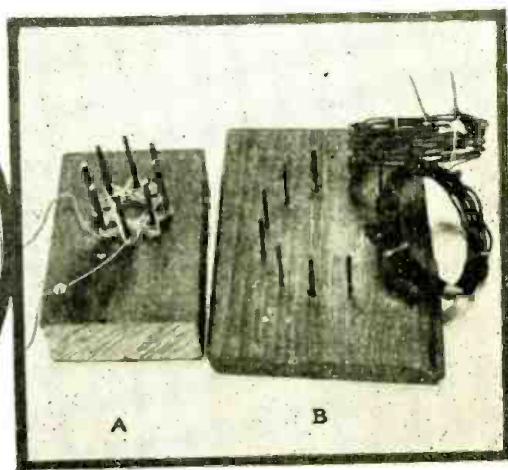
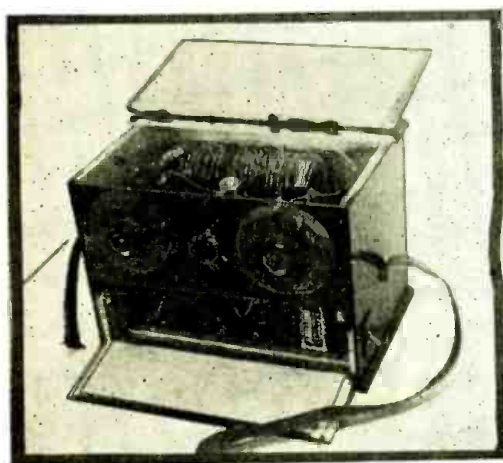

The transmitting unit is pictured at the left. The author is shown in the center picture, operating the completed station; the barrel is necessary for keeping the units away from the ground. The coil winding jig is shown in the picture on the right. The photographs show slight differences in the panel sizes, etc., of the two sets due to the use of discarded material, such as dials, etc., and the panels made to fit.

TO be actually portable, a transmitter should be so constructed that it can be carried about in the hand if necessary. (This portable weighs only 30 pounds.) This is only possible with short wave transmitters because communication over any distance cannot be carried on, on the higher bands, with the low power such a transmitter would be able to offer. It was with this in mind that the portable transmitter shown in the photographs, together with its twin, a three tube receiver, was constructed.

Features

While, of course, not the last word in short wave outfits, it is entirely practical. The transmitter is a 40 meter affair operating on 67½ volts plate current and a "C" battery to light the filament of its tube, which is a 199. The hookup used has a known record of 2,000 miles per watt under good conditions and from 500 to 1,000 miles can be attained by this transmitter under as good conditions with this power supply, which delivers in the vicinity of .4 of a watt. It is thus excellent for so-called local work but may often surprise the user by making contact over unbelievable distances.

The receiver is a conventional Schnell circuit with two stages of audio amplification contained in a case of identically

the same size. This uses 199 type tubes also and operates from three dry cells and a small 22½ volt "B" battery.

The filaments of both transmitter and receiver are controlled by 125 ohm rheostats; which makes it possible to light the tubes direct from a car battery if so desired. In other words the sets can be operated from a three, four or six or even an eight volt source if the contained "A" batteries fail for any reason. An extra "B" battery block can also be carried along if desired for boosting up the plate current of the transmitter, although this is optional. Even a Ford spark coil can be used for plate current by connecting top side contact to "A" plus, (bottom side contact is the "B" plus line) and the bottom contact of coil to the key and the other key lead to "A" minus. Besides the two units there are in addition the key, headset and antenna-counterpoise wires—all of which can be stuffed in a couple of pockets.

The transmitter is known as the Split Colpitts circuit having tuned plate and grid and a consequent absence of clips to adjust. Only two are included and are used to connect the outer end of each tuning coil.

Transmitter Details

The base is a thin board 11 inches long by 7 inches deep. The panel is of

hard rubber 11½ inches long by 4½ inches high. Two .00025 mfd. variable condensers are used for tuning and are mounted at each end of the panel. The rheostat is mounted in the center. The tube socket is mounted on the base just back of the rheostat. Back of that comes a .001 mfd. fixed condenser and back of each tuning condenser is placed a choke coil. A 5,000 ohm transmitter-type grid leak of good quality is then mounted at the back right hand corner of the base and then the tuning coils occupy the space parallel with the rear edge of the base.

The transmitter coils consist of two separate air windings of No. 12 or No. 14 bare copper wire of seven turns each. Their mountings consist of two hardwood sticks; one 8½ inches long and the other 7½ inches long. The shortest one is notched underneath at ¼-inch intervals and arranged to leave 2 inches between the coils. Coils are then set in position on the long stick and the short one placed through the coils and screwed down to the bottom one, the notches bearing down on the coils and holding them vertical and rigid. Then the ends of the bottom stick are screwed to the base as shown.

The antenna coil consists of five turns of the same gauge wire arranged as shown in the sketch. This is placed be-

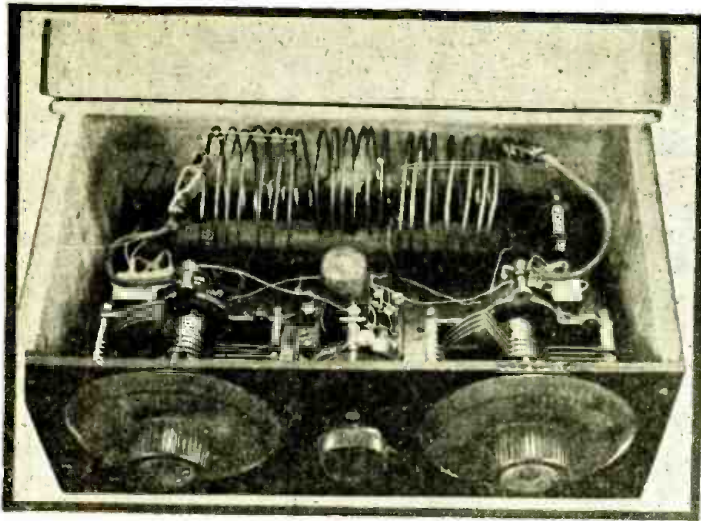

This close-up of the transmitting unit illustrates the general arrangement of the short wave coils and condensers. Note the antenna (middle) coil coupling.

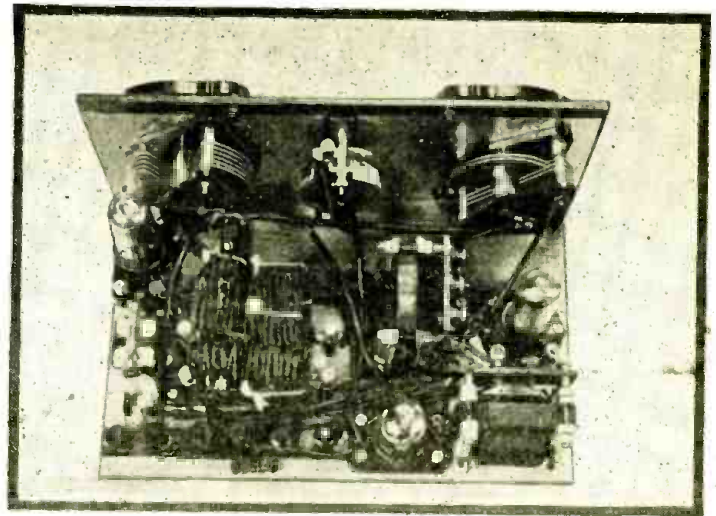

A close-up showing the arrangement of the parts which constitute the receiver. The basket wound "bell wire" coils will not absorb moisture very appreciably in damp localities.

tween the two main inductances and their ends are clipped into two Fahnestock clips fastened to the baseboard.

The form for winding the chokes is shown in both sketch and photograph. Eight long, headless wire nails are driven, in a 1 3/4 inch circle, in a board. Then, 40 turns of No. 22 DCC. copper wire are wound around them to form an eight-pointed star. This is done by winding around one nail, then skipping inside two, around the fourth nail and so on until 40 complete turns have been made. Their hold-downs consist of a little piece of thin wood placed over them and held to the base by a match stuck in a hole in the base. This is shown in detail sketch. By following the schematic diagram and the accompanying photographs all constants will be found and the layout and wiring are fully explained. All battery connectors consist of Fahnestock clips fastened to the base with flexible wire leads of sufficient length.

The key is attached to a piece of thin board 10 inches long with two straps

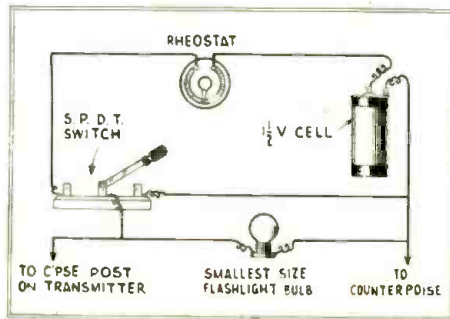

Schematic circuit of the resonance indicator designed for the 30-lb. portable transmitter.

underneath for strapping it around the leg of the operator. Two leads of insulated flexible wire serve to connect it to the clips in the back of the transmitter.

For the transmitter three blocks of "B" battery 5 1/4 x 2 1/2 x 3 inches, totaling 67 1/2 volts, and one or two "C" batteries furnish the power. The "B" batteries are wired direct to the clips above on the base board and the "C" batteries

are wired to the usual "A" battery posts through the toggle switch.

It must be remembered that the "A" power of the transmitter is small and the latter should be turned off at the end of each transmission but, notwithstanding that, a single "C" battery will furnish power for upward of 100 operating hours. The small "B" batteries should last for 3 to 5 months with average use depending upon the quality and size used.

Receiver Assembly

Assembly of the receiver should offer no serious difficulties. The base and panel are the same size as used for the transmitter. Variable condensers and rheostat are mounted in the same relation. The antenna coupling condenser consists of two little plates of brass or copper 1/2 inch square and separated a sixteenth to an eighth of an inch. A stiff wire soldered to one plate allows it to be slid through a binding post hole and proper adjustment thus made. The inductance coils are wound of common

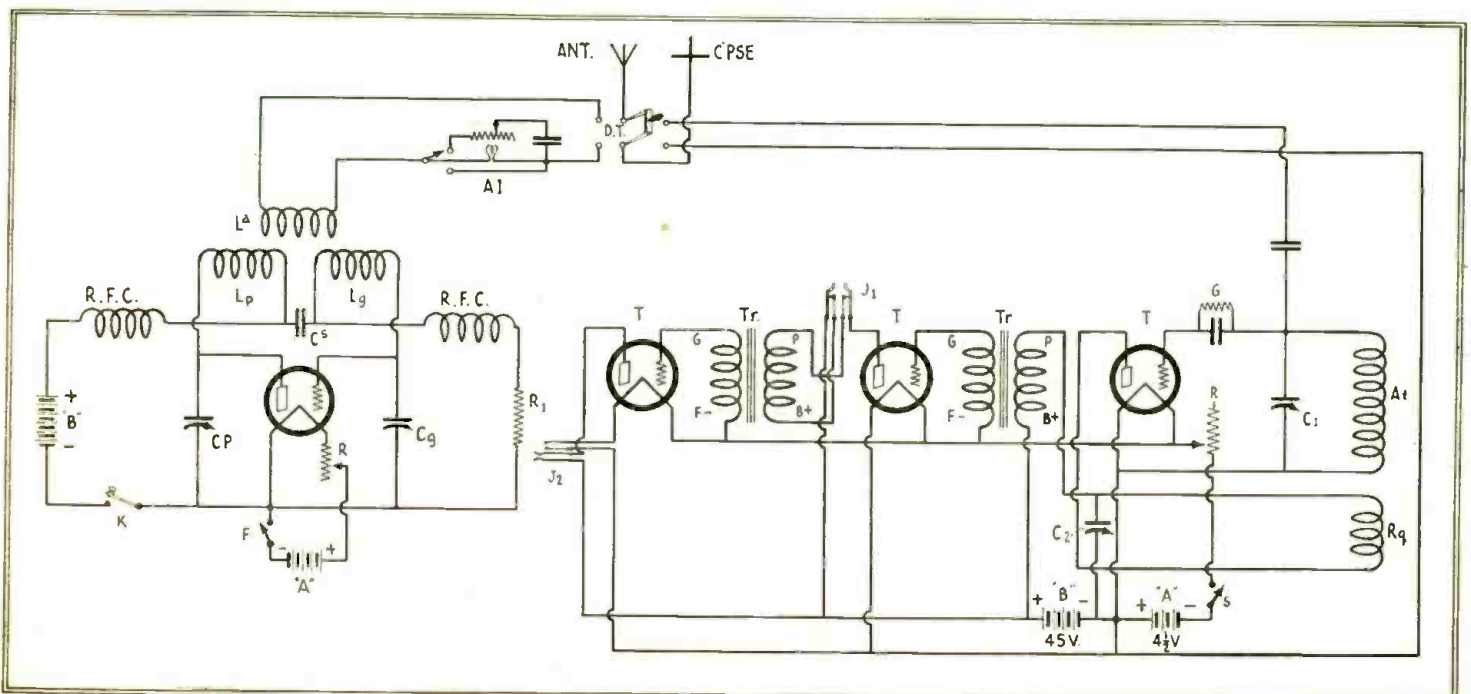

Schematic circuit of the complete portable transmitting and receiving radio set designed by Mr. Robbins. The antenna is not tightly coupled to the transmitter, the antenna coil being in adjustable relation to the oscillator coils.

No. 18 bell wire around a 3-inch form. This consists of 11 nails driven into a board in a 3-inch circle. Then wind the wire around every other nail as indicated in sketch and photograph. Owing to the slight difference in makes of condensers a definite number of turns for these coils cannot be given but in the set shown 7 turns are used for the antenna tuning and 8 turns for the regeneration control. As just stated this may vary according to the size plates in the condensers used and can only be found by trial. The ends of the coils should be both brought out to one side and spaced about 1½ inches apart.

The coil mounting table is a piece of panel stock 4½ inches long by 2¼ inches wide with a pair of side hole binding posts at each end 1½ inches apart. These are wired to the circuit as indicated and the table raised above the base by four insulating washers just high enough for other wiring to pass under it. Spaghetti is used in all wiring because the set is so compact; consequently, grid and plate leads must be short and placed with care to prevent capacity coupling. A binding post strip is placed along the rear edge of the base. The first audio stage is in circuit with a two

circuit jack while the second stage is connected to a filament jack which automatically controls the last tube when the plug is inserted. The panel is shielded with tinfoil shellacked on and the shield grounded.

For the receiver, one 22½ volt "B" battery of the same size as the ones in the transmitter is wired direct to the "B" circuit while three regulation size dry cells are wired to the filament circuit through the toggle switch. When wiring is completed the space left around the batteries should be stuffed with strawboard or paper to prevent the batteries from joggling around.

The Carrying Cases

The two cases are identical. These are built of one-half inch finished pine as the dimensions in the diagram show. (They were then stained mahogany and presented a very pleasing appearance, for a home made job.) The outside dimensions need not be exact, but the inside measures just 11 inches across by 7¼ inches wide and 8 inches deep. Two thin wood cleats are nailed across each end, upon which the base board of the set is slid into the case, and allow the top edge of the panel to come just flush

with the top edge of the case. The front edges of the sides are mortised to receive the thickness of the panel and the edges of the battery compartment door below. This door is cut to fit and its ends also mortised to fit the side piece mortising. It is hinged from below so it swings down. A 1½ inch strip of wood across the back of the top furnishes ample wood to hinge the top which hooks down at one side as shown. A carrying strap, with buckle, is attached to each side and completes the case. The panel fastens to the side piece edges with four small screws which allow it to be quickly removed if necessary.

Four double Fahnestock clips should be fastened to the back of the transmitter case. The antenna and counterpoise connections are clipped into one pair, while the key connections are clipped into the other clips. Two double Fahnestock clips only are needed on the back of the receiver for antenna and counterpoise wires. Other clips may be placed on the cases of course, if outside connections are to be occasionally made to additional power sources (such as spark coil, outside storage batteries, etc.), but these can be easily added by the builder after his own devices.

Final Adjustments

Setting up and operating this outfit is very simple, but a few words regarding it may not be amiss. For handiest operation the transmitter is placed at the left and the receiver at the right. The resonance indicator is placed between them with the double throw switch at the rear. Then the antenna and counterpoise are erected and drawn as taut as possible. The set ends are connected to the knife posts of the double throw double pole switch as indicated. Then the proper leads are connected to the transmitter and the receiver, also shown in the sketch.

The antenna consists of a 33 ft. length of small gauge braided insulated wire with an insulator at one end and carefully scraped to bright copper at the other. The counterpoise can be about the same length. The writer carries each one on an old fishline reel thus making them convenient for carrying. A hook or cord at the insulator end makes it convenient for fastening to a tree or other support.

A simple resonance indicator was made as illustrated in the cut. This consisted of a single pole double throw switch, a rheostat, a single cell of flashlight battery and the smallest flashlight bulb obtainable, with socket. When arranged as shown it acts as a shunt across the counterpoise lead with the switch thrown in one direction but cuts it out of the circuit with the switch thrown in the opposite direction. The switch blade is connected to the counterpoise lead direct, and the counterpoise itself to the lower contact of the switch. With the flashlight in shunt, turn on the rheostat until the light just glows. Then when the transmitter is brought in tune and is in resonance with the antenna the light will brighten up. With this determined, throw the switch to the opposite side and the output will go out direct. This saves the expense of buying an antenna meter. A double pole double throw

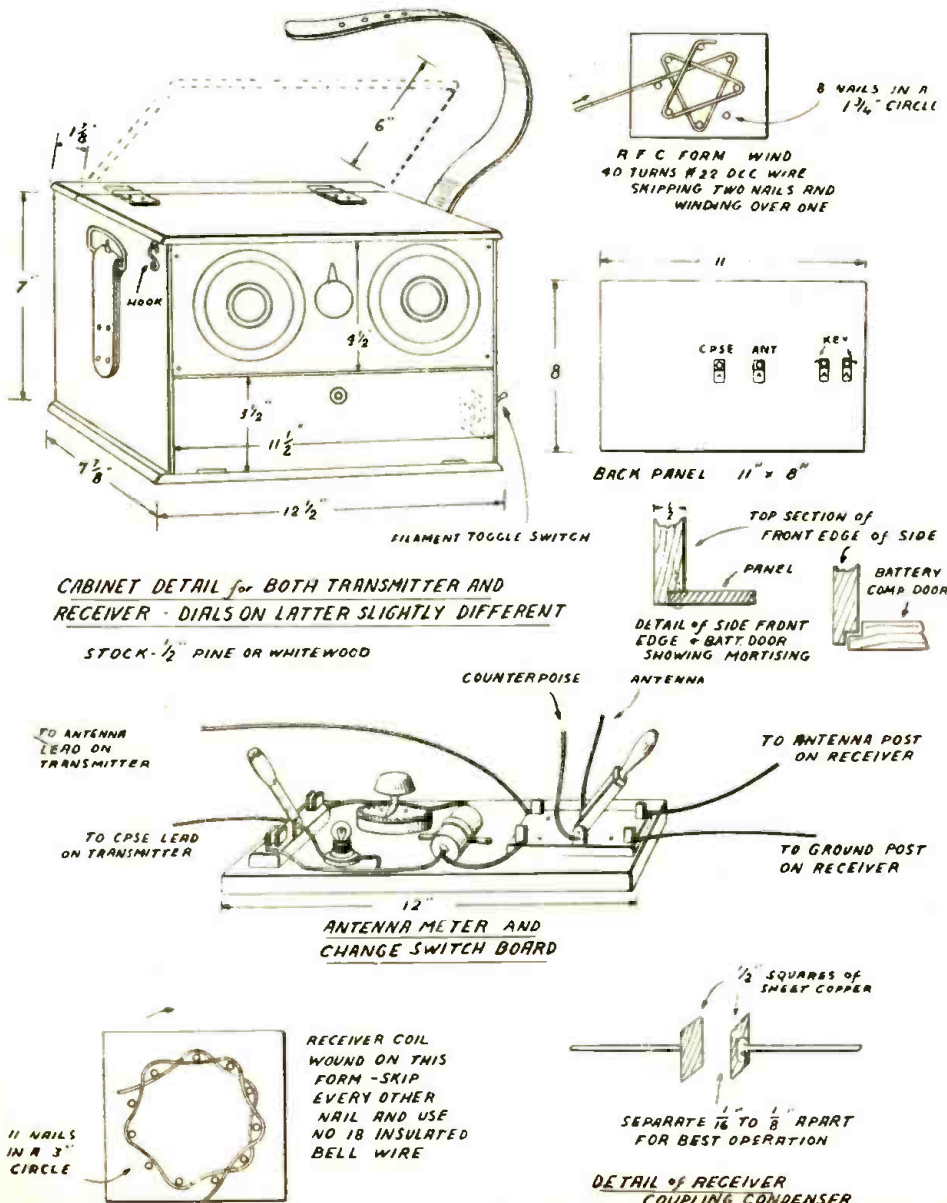

Arrangement of parts for the antenna and radiation controls, and construction details of the cabinet which is similar for the receiver and the transmitter.

switch at the other end of the board serves to transfer counterpoise and antenna from receiver to transmitter as needed.

Antenna and counterpoise are switched over to the transmitter side and the transmitter tuned to resonance by the indicator at the desired wave length; after, of course, lighting the tube by means of the toggle switch. After the CQ is given, the tube is switched off and the antenna and counterpoise switched over to the receiver. This is switched on and the reply hunted for as usual. When contact is established the same procedure with the antenna-counterpoise switch is repeated as replies are given and answers received. When finished the entire outfit can be packed up in five minutes for transport.

Don't expect to crowd out the big fellows with a hundred watts or more at their command; however, with careful tuning of the circuit and choosing periods when the air is not over-crowded this outfit will furnish plenty of contacts and will do surprising work. It is just the thing for the amateur when on a vacation or even for local work at the home station. Moreover, it is inexpensive to build, simple to operate and gives a wonderfully clear, sharp note that can be read through much interference.

Acknowledgment

In justice to the Burgess Battery Co. of Madison, Wis., it should be stated that

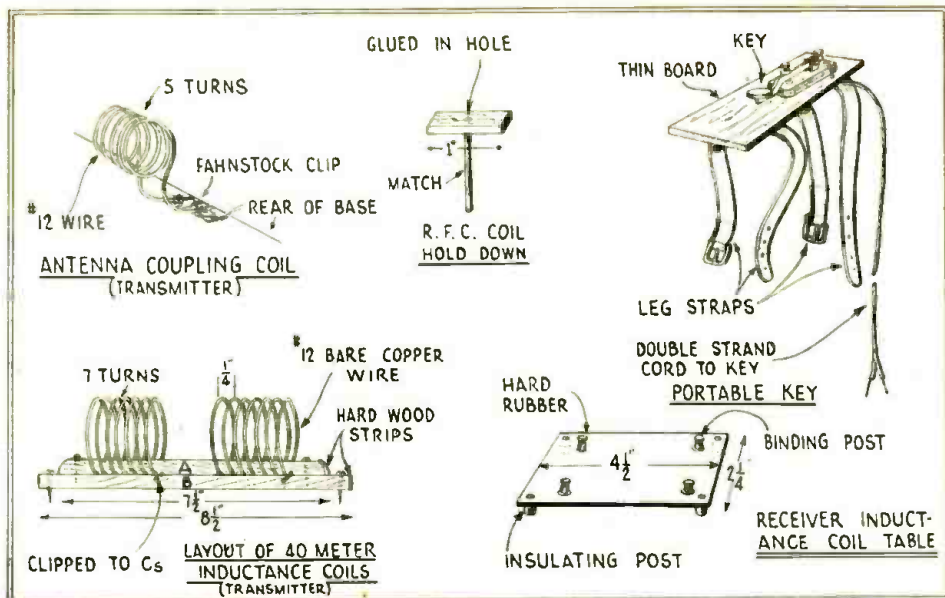

Mechanical details of the transmitter and receiver components. This is a very inexpensive radio design.

this transmitter circuit was developed by them and has shown wonderful results in actual practice. The writer has also found it very efficient although making several minor changes in the design.

Receiver reference data—Antenna series coupling condenser, 1/2 in. sq. plates; G—Grid leak and condenser, 2 megs. and .00025; At—Antenna coil, 7 turns; Rg—Regeneration coil, 9 turns; S—Filament switch; A—4 1/2-volt C battery; B—45-volt B battery; C1—5-plate variable condenser; C2—11-plate

variable condenser; T—Three 199 tubes; Tr—Two 3 1/2 to 1 transformers; J1—Double circuit jack; J2—Filament control jack; R—Filament rheostat, 125 ohms.

Transmitter reference data: A—4 1/2-volt C battery; B—67 1/2-volt B battery; Cg and Cp—Two .00025 variable condensers, 9-plate; Cs—.001 mica condenser; Lg and Lp—Two 7-turn coils, 3 in. in diameter; La—Antenna coupling coil, 5 turns; T—199 type tube; R1—5,000-ohm grid leak; R—Filament rheostat, 125 ohms; RfC—Two 40-turn chokes; K—Key; A1—Antenna indicator; DT—Double pole double throw switch; F—Filament switch.

Some Notes on Short-Wave Operation

The "How?" and "Why?" of successful short-wave reception clearly and interestingly explained.

By ROBERT HERTZBERG

MOST owners of short wave receivers do not fully appreciate the fact that the entire success of their outfits depends on how smoothly and easily they can control the regenerative action of the detector tube. Many carefully and beautifully built receivers using the most expensive parts do not produce more than a few weak local broadcast stations and possibly a dozen loud telegraph stations, simply because the detectors collapse into oscillation with a pronounced "plop." Many carelessly assembled sets using parts retrieved from the junk box bring in 'phone stations from all over the world, because the regenerative action is under nice control.

The question is, "How can the regenerative action be made smooth?"

Balancing the Regenerator

The problem is an easy one to solve, providing you have just a little patience. First of all, the size of the tickler must be just right. Most short wave plug-in coils are of such simple construction that turns of wire can be added or removed without difficulty. The idea is this:

Start off with the smallest coil. Turn the tuning condenser to 100, and start advancing the regeneration condenser (or variable resistor, if you are using this method of control). If the tickler is just the right size by some accident,

the circuit will go into oscillation as the regeneration condenser reaches maximum capacity. If you find that you need only a fraction of the capacity, you can employ less tickler, and accordingly you should remove the coil and unwind one turn—but not more. One turn of wire on a small coil makes a lot of difference sometimes. Put the coil back and again experiment with the regeneration control. You will find that you now need more capacity.

With a little experimenting, you can strike just the right amount of tickler winding that will make the circuit oscillate with the regeneration condenser turned to about 90 or 95. Do not work

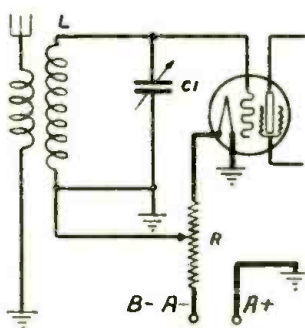

Fig. 4. Incorrect. Although this puts the rotor of the variable condenser at ground potential, it shorts the "A" supply.

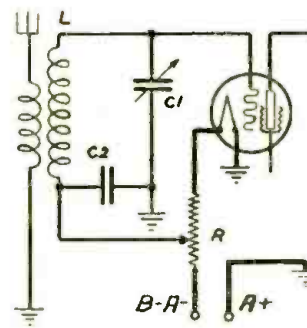

Fig. 5. Correct. With this connection the variable condenser rotor is at ground potential without shorting the filament supply.

too near 100, as you may have to raise the "B" voltage if the "A" battery should fall low sometime.

As you turn the tuning condenser from 100 to 0, you will find that you need less and less of the regeneration condenser. The smallest possible size tickler for the highest wavelength setting of the coil will result in the smoothest regenerative action.

With a great many plug-in coils, the circuit will oscillate only up to 80 or 85 on the tuning dial. This indicates that the tickler is too small, but before adding wire to it, try a different detector tube, or raise the plate voltage a little.

(Continued on page 89)

How To Build A Two-In-One Receiver

A most novel arrangement, permitting double-band reception without need for changing coils (in the usual sense). A switching system changes from one range to the other. This is a practical scheme. Additional bands may be provided by the exercise of a little ingenuity.

By LOUIS B. SKLAR

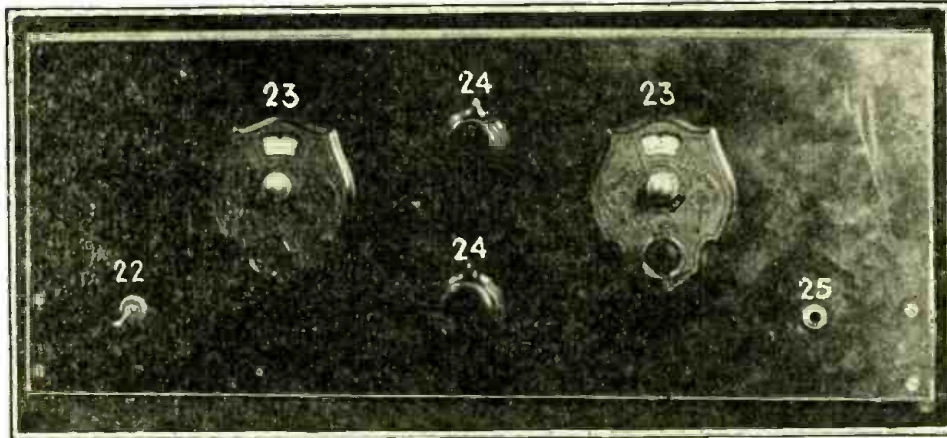

At right (above), panel arrangement of the "Two-In-One" receiver. The dials are of the illuminated type. If operation of the circuit - change switch is desired at the panel, one additional control knob will require to be provided for.

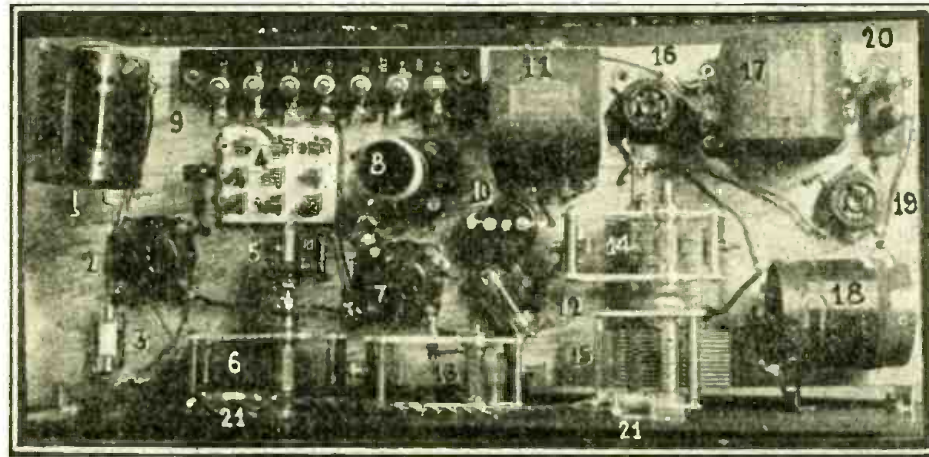

At left (below), parts layout of the 2-band receiver. The porcelain-base switch shown may be replaced by a good make of low-capacity, panel-operated switch. It may be advisable to make special mountings to hold the variable condensers rigidly. At the shorter wavelengths any undesirable motion of the variable condensers will make tuning difficult.

THE radio set to be described is a combination short-wave and broadcast wave receiver. (The range of this particular receiver was from thirty to five hundred fifty meters.)

This radio receiver differs radically from all other types. There are no adapters and no extra tuning dials. The change over from the broadcast wave to short wave and *vice versa* is accomplished by the turn or movement of a three pole double throw switch. Of course when you want to get the full range of the short wave channels, it will require changing the plug-in type coils for the various wave lengths. The radio fan will soon find, however, that a few of his favorite short-wave stations will come in on one and only seldom on two coils. In this case, he will leave a particular coil permanently in the set.

The same two tuning dials used for the operation on the broadcast wave channels are used on the short waves; the same tickler or regeneration control is used for all wave lengths.

I have constructed this set and had it in operation for several months with excellent results. It was satisfactory as a short-wave receiver, enabling me to reach distant stations, which I could not

get with the regular broadcast receiver. It was also a sort of pleasure that this was obtained without any extra attachments and with the least effort.

Many times when my friends listened to distant stations coming from the loud speaker of this radio set they wondered how such great distance could be received with an ordinary four-tube set. There wasn't anything different in the method of tuning to lead my friends to suspect that a short-wave receiver was hidden somewhere in the console in which the radio set is housed. When signals faded only an expert would suspect "short waves."

The use of short waves has long been advocated for reception during the summer months when static is most prevalent. (In the countries of the torrid zone, short-wave operation is the only satisfactory means of communication with distant points.) If broadcast reception on the short waves is distorted, it will almost certainly be due to heterodyning between the short-wave fundamental and the harmonic of some higher wave station, or to its being one of the harmonics and not the fundamental frequency of the station to which you are listening.

Method of Construction

The construction of this Two-in-One Receiver is extremely simple. Anyone who knows how to handle a soldering iron and can follow a radio schematic diagram will have little trouble in building it.

The schematic diagram shown in Fig. 1 illustrates the way in which the set is changed from a long-wave to a short-wave receiver. Fig. 2 shows the mounting of the short wave condenser and how it is coupled to the shaft of the long-wave condenser. The coupling used on the first or radio frequency stage condenser is an insulating type coupling; the one used on the detector circuit tuning condenser is a metallic coupling. The two photographs and list of materials should enable anyone to get the proper parts and arrange them on the front and sub-panel for best results.

The three-pole double-throw switch can be of the "jack" type. When this type switch is used the change over can be made by shifting the small knob on the front panel; or, an ordinary blade type disconnecting switch as shown in the photograph can be used. In the latter case it will be necessary to "get inside the set" (to use a colloquialism) to make the change over.

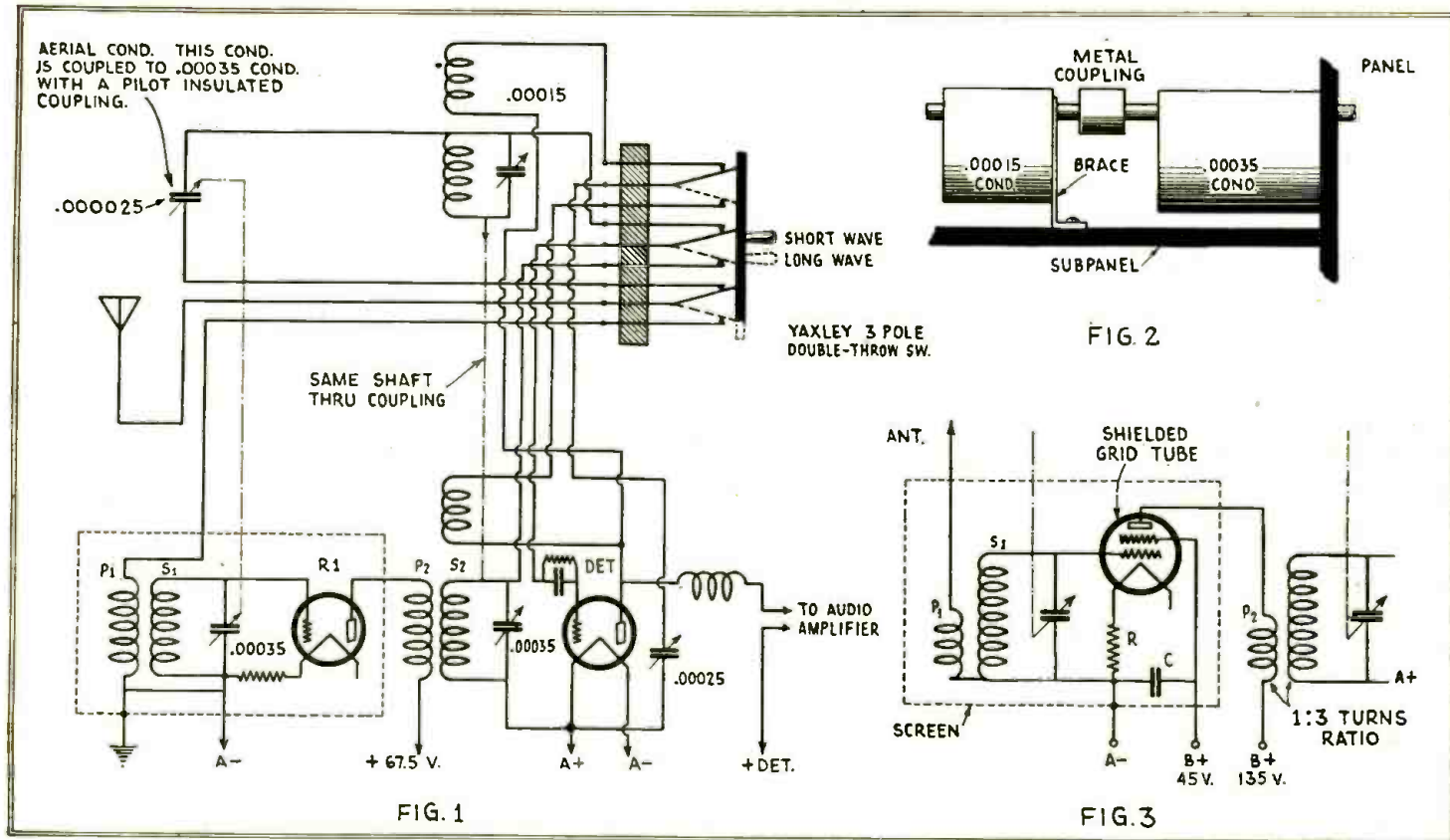

Schematic circuit of the dual-range receiver described by Mr. Sklar. Fig. 3 illustrates the circuit to be used if a screen (shielded) grid tube is used as *R1*. It will be necessary to use particular care when shielding the parts associated with this tube, as indicated by dotted lines. This receiver will function very differently on different antennas, during short wave reception.

Method of Tuning

I believe that there is no need of explaining how to tune the regular broadcast receiver. As to the short-wave part of the receiver, the method of operation is somewhat similar to any regenerative type of radio set. To tune in short wave transmissions the tuning operation must be done very slowly. A little patience and a few days' practice will enable you to tune this set instinctively and you will be able to tune in the short-wave stations without any difficulty.

The radio enthusiast building this two-in-one receiver will find that he will be amply repaid for his effort.

Anyone having a four-tube set similar to the long-wave part of the receiver herein described can very easily change it to a two-in-one radio set by making the necessary changes and additions.

List of Materials

1. Radio Frequency Stage Transformer.
2. Radio Frequency Stage Socket.
3. Fixed Resistor for R.F. and 2 Audio Tubes.
4. 3 Pole Double Throw Switch.
5. .000025 Variable Condenser.
6. .00035 Variable Condenser.
7. Detector Tube Socket.
8. Short-wave Plug-in Coil Socket. (4 coils required.)
9. Binding Post Strip.
10. R.F. Choke.
11. First Audio Stage Transformer.
12. Grid Leak and Condenser.
13. .00025 Variable Condenser.
14. .00015 Variable Condenser.
15. .00035 Variable Condenser.
16. 1st Audio Stage Socket.
17. 2nd Audio Stage Transformer.
18. Detector Stage R.F. Coil with Fixed Tickler.
19. 2nd Audio Stage Socket.

20. Loud Speaker Binding Posts.
21. Dial Illuminating Bulbs.
22. Battery Switch.
23. Dials.
24. Knobs.
25. First Audio Jack.

Rheostat for Detector Tube. Set of Short-Wave Coils, Tubes, Batteries, Coupling, etc. Condenser Couplings, one insulating, and one metallic. (Hammarlund and Pilot are concerns making them.)

Using the '22 Tube

There will be little difficulty in adapting this circuit to the use of Type '22 tubes. As these tubes have a tremendous amplification factor at radio frequencies, many experimenters will want to incorporate one in their construction plans. The original receiver did not use the '22 tube but there is no reason why it could not be incorporated in the set.

However, it must be remembered that the signal output of screen grid tubes is very high and many set builders will say that the use of the screen grid tube will result in very broad tuning. Whether this actually proves to be true will depend upon the care used in adapting the tube, and in the particular reception conditions encountered. In sections having several powerful stations, it may not be advisable to use the '22.

It will be necessary to shield the input circuit of the screen grid tube, to realize maximum amplification with the least regeneration. It was not necessary to shield the original receiver as it did not incorporate the screen grid tube.

Secondaries S1 and S2 will consist of a certain number of turns as determined by the capacity of the particular variable condensers used.

Primary P1 must be made with very

small wire, as the coil must have very small dimensions. It is wound at the filament end of the secondary, as is primary P2. The number of turns in coil P1 is controlled by local reception conditions and the particular aerial used.

Primary P2 is also wound with very fine wire and contains about one-third the number of turns on the secondary.

It is to be noted that the filament resistance indicated as R, must be about 10 to 15 ohms. Additional resistance may be cut into the positive "A" lead to reduce the "A" voltage at the tube filament to the required value. The necessity for having a certain resistance value for R is the "C" bias requirement of the tube; resistance R supplies this and a special battery for the purpose is not needed.

Condenser C may have a value of about one-quarter microfarad.

For satisfactory short-wave reception it will be necessary to arrange the aerial so that it does not swing badly, or the result will be pronounced fading and swinging of signals. Fading is a rise and fall in volume, at one wave length, compensated by variation of the volume control (adjustments of the tuning controls do not increase the signal volume); swinging is wave length variation and is manifest by a rise and fall of volume which can be compensated by readjustment of the tuning control. If the circuits are not retuned, there will probably be considerable distortion of voice or music. As this swinging may occur so rapidly that only an oscillograph would be able to indicate it, we see how it is impossible to correct swinging at times; and we learn one of the underlying causes of voice distortion at short wave lengths.



Manufacturers are invited to send to this department photos and descriptions of new apparatus

A Practical Line Interference Eliminator

The introduction of a resistance-capacity shunt in a filter bank is found to produce new and desirable effects.

By ALEX. GORDON HELLER*

THE mere word "eliminator" is a regular "red flag" to many who are commercially interested in radio. Too often it has been found that certain "eliminators" were misnamed. There is now available, however, a unit to which the term "interference eliminator" may be justly applied.

It may be well to gloss over the interference situation. There are two general classifications, the "domestic" and the "imported." "Domestic" troubles are usually due to defective radio parts or wiring, and there will be no relief until there is a correction of fundamental faults.

ceiver or arriving via the light lines. If the proper filter is applied, the latter situation will be corrected; the former must be dealt with as above.

The unit pictured at right incorporates a fixed resistance and a fixed condenser; used with the larger unit described, certain combinations may be found particularly effective.

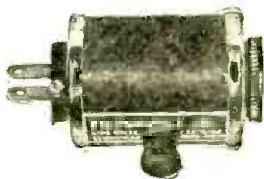

With some more sensitive receivers of the unshielded types there may be considerable pick-up of interfering sounds by the unshielded components. The remedy for this, of course, is to shield the wiring and instruments.

Therefore, we find only two types of interference pick-up which may require special treatment; that which comes through the antenna and that introduced into the receiver from the light lines.

Antenna interference pick-up may be distinguished as "static," due to electric storms, distorted reception due to peculiar types of inter-station cross-talk and frequency mixing; or distorted reception due to pick-up of high-frequency "strays" originating in defective electric wiring and equipment, or the normal operation of certain apparatus (as instance the sparking motor brush and the disturbance created when lights are switched off or on).

Heretofore, it has been considered almost impossible to alleviate antenna pick-up of this sort. Nevertheless, satisfactory operation has been obtained in many cases by connecting an additional wire from the antenna post of the set to a plug which will fit the receptacle on a filter which shunts the line supply. In some instances the regular antenna

has been removed entirely with improved results, the "filtered" antenna being used instead. About 20 to 50 feet of wire should be included between the set and the filter unit for this purpose.

Line Interference Pick-up

If the trouble can be localized to a particular electrical device, it will be most convenient to plug this troublesome unit into the filter receptacle and plug the filter into the light-line receptacle. The carrying capacity is sufficient for motors as high as one-half horsepower. Whether a ground wire should be led to the filter connection provided is a matter to be determined by experiment.

If the trouble is not so easily located, the second expedient is used; that is, the radio set is plugged into the filter and the filter into the light line. Again the result of a ground lead cannot be forecast; its use may either increase or decrease the interference.

High-Voltage Problem

There are certain exaggerated types of interference which we cannot hope to correct without a considerably more complicated procedure; such as the unusual conditions which result when a high-voltage transmission line's insulator breaks down and arcing results. Even a very much domestic item (an ultra-violet-ray machine of the type which consists of a focusing reflector and electric arc) may cause the most intense interference with radio sets within a considerable area. In this instance it is desirable to install one of these filters between the ray machine and the wall receptacle. Electric refrigerators and the equipment of oil burners cause milder, but still objectionable, interference. It is not usually convenient to apply large by-pass condensers directly to the offending equipment, and again the filter unit is of major aid when attached as described for other "static" generating instruments.

A well-designed filter will eliminate most forms of interference, but there are a few types of exaggerated line-surge and shock excitation almost impossible to eliminate. By using the particular circuit shown, these forms of program



The "Filtervolt." A commercial product incorporating a new circuit.

The "imported" brand does not originate inside the radio set and sub-divides into types describable and indescribable. In general the listener usually chooses to term "static" anything which interferes with his reception of programs.

Fortunately there are a few simple tests which readily localize this "QRN."

Trouble Shooting

If the noise stops when the antenna is disconnected, the trouble has been localized to antenna pick-up. Otherwise the noises are originating inside the re-

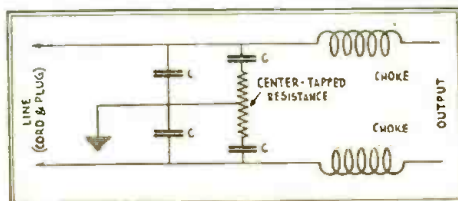

Schematic circuit of the unusual filter arrangement described in the accompanying article.

*Technical Director, Insuline Corporation of America

interference have been corrected where all other methods failed. Condensers C are 2 Mf. each. The air core chokes are made by winding 250 turns of number 18 D. C. C. wire on a form 1½ inch in diameter and 1¼ inches long. It seems that the special resistance-shunt here utilized (which has a relatively constant temperature resistance coefficient) acts both as a line-voltage stabilizer and a surge equalizer. The exact value has not been made public, but an approximate value for experimentation would be 250 to 300 ohms on each side.

As will be evident from examination of the schematic circuit, the surge damping resistance draws no current, as it is direct current-insulated by fixed condensers. This is the final development of an experimental model which had a resistance conductively shunting the line and therefore continuously drawing current.

THE DAYTON "NAVIGATOR" RADIO

THE A.C. Dayton Company, of Dayton, Ohio, has developed a new radio set for the ensuing season; the chassis is pictured herewith. The receiver is obtainable in two models, the table type (Model AC-98) at a list price of \$108.00, and a console receiver (Model AC-99), listing at \$188.00.

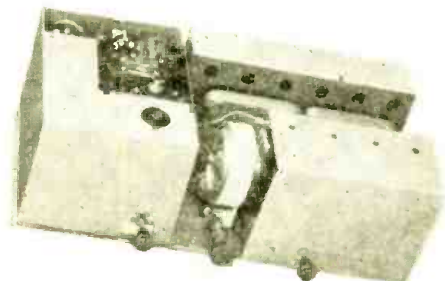

The "Navigator" chassis is depicted above. It incorporates one of several special circuits, all developed and licensed under the name "Technidyne." All tuning is done in the aerial circuits.

The "high lights" of the Model AC-99 Console are set forth below:

- Fuse protection of A.C. supply and radio set;
- Nine tubes (including rectifier);
- Dynamic reproducer (11-inch Jensen);
- Single-dial control;
- Dial is calibrated in both the regular numeral system and in kilocycles;
- Caswell-Runyon cabinet.
- Tapped transformer for balancing line-voltage conditions;
- Mershon filter condensers.
- Push-pull, type '45 tube circuit;
- Provision for use of magnetic reproducer, or dynamic-type reproducer, in both A.C. and D.C. models, and phonograph pick-up connections;
- All electric operation;
- Unusually artistic and "theme" design of dial escutcheon, to correspond with the name ("Navigator").
- A complete set of tubes includes six type-'27, two '45, and one '80. The type-'27 tube sockets are green, the '80 is yellow and the '45s are orange.
- The circuit is the "Technidyne" system of "Pre-selection." The signal is tuned in, and all undesired signals are eliminated by a band-pass, band-selector arrangement, before any amplification takes place. The tuning condensers are

in this filter circuit and not in "tuned stages of R.F. amplification."

The chassis measures 7"x20¾"x10¾" deep.

THE "STAR RAIDER" RP-40 RADIO-PHONOGRAPH

THE above is the rather fantastic name of the latest radio receiver produced by the Continental Radio Corporation, (Formerly, Slagle Radio Company), Fort Wayne, Ind. It is obtainable as a complete console receiver and has the following points of merit:

- A special 14-inch dynamic reproducer, designed for the "Star-Raider;"
- A "C"-bias detector;
- Single stage of audio-frequency amplification (Push-pull) with type-'50 tubes;
- Two-knob control—one for tuning and one for volume;
- Dial calibration in kilocycles;
- Antenna variation compensation;
- Tapped primary and series resistance for line-voltage control;
- Six stages of R.F. amplification;
- Eleven tubes (including rectifiers);
- High safety factor in condenser design;
- Phonograph pickup;
- Phonograph turntable and noiseless motor;
- Phonograph record albums;
- Cabinet of ¾-inch solid walnut, embellished with imported wood inlays and hand carvings of selected walnut.

VARIABLE VOLTAGE REGULATOR

THE makers of "Dim-a-Lite," the Wirt Company, Philadelphia, Pa., announce a line-voltage regulator with several interesting features.

The Type 211 unit is a light-duty instrument, to be used for current drains not exceeding 65 watts. The Type 211-B instrument is designed to be used where current exceeding 65 watts, and up to 150 watts, is required. The Type 211 lists at \$2.25; the Type 211-B, \$3.25.

Paste this table in your note book: Assuming the line potential is 125 volts and that the radio set requires a power of (A), 75 watts; (B), 100 watts; (C), 125 watts; or, (D), 150 watts, the output voltages will be:

Position	(A)	(B)	(C)	(D)
1	119	117	115	114
2	118	115	113	111
3	116	113	110	108
4	115	111	108	106
5	113	109	106	104
6	112	107	103	101
7	110	105	101	99
8	109	103	100	97

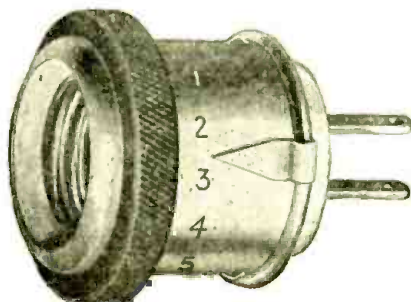

The service man will find the Type 211 unit shown above a convenient control to introduce into the A.C. line for reducing the voltage.



The fact that only one stage of audio-frequency amplification is used may contribute greatly to the characteristic of the "Star Raider," pictured above, which is said to be flat between 30 and 10,000 cycles. The list price of the Model RP-40 is \$725.00. There are other models at lower figures, though using the same circuit.

A RADIO WITH A BAND SELECTOR

THE Silver chassis pictured is the instrument portion of the new console radio creation by the Silver-Marshall organization. The new receiver is available in two cabinets, the "Lowboy" and the "Highboy."

Note some of the really remarkable developments in the list of features of the Silver Radio.

- Full A. C. operation;



The chassis pictured above is part of the Console Radio with which the Silver-Marshall organization makes its entry into the field of complete sets; at the same time their parts business will be continued and expanded.

- Three stages of screen-grid radio-frequency amplification;
- Single-dial tuning;
- A screen-grid tube as a power detector;
- Type '45 tubes as push-pull audio amplifiers;
- Built-in voltage-regulator unit;
- Band-selector circuit design;
- Volume-limiting effect (an automatic condition due to the circuit arrangement);
- Extremely wide audio-frequency response, with a special high-frequency cut-off switch and dynamic reproducer;
- Built-in, non-directional antenna;
- Kilocycle dial calibration;
- The list price of the Lowboy is \$160.00, and of the Highboy, \$195.00.
- The perforated can between the two tubes covers the voltage-regulator.
- A complete set of tubes includes: four, '24; one, '27; two, '45; and one type '80 tube.



RADIO CRAFT KINKS

When submitting contributions to this department, Radio Craft Kinks should be written on one side of sheet only, and no other department material should appear on these sheets. The proper way to address the letter is: "Radio Craft Kinks" Department, care of Radio-Craft Magazine, 98 Park Place, New York City.

MEASURING THE FUNDAMENTAL WAVELENGTH OF A COIL OR A COIL AND CONDENSER COMBINATION

By Melvern H. Berry

EVERY Radio Fan has known of a time when he would give a portion of his anatomy to have some means to test the fundamental wavelength of his coils before placing them in his set to see what they would do. Of course, some approximate idea

measured, and when the resonance of the meter is adjusted to coincide with the frequency of the oscillator there will be a second deflection of the galvanometer towards zero. The actual maximum fundamental can be read directly from the meter or from the curve.

When using as a test for the wavelength of a coil and condenser combination, refer to Fig. 2.

It will be necessary to put a radio frequency choke coil in the lead from

It must be remembered that loose coupling must be maintained between coils, if maximum accuracy is to be realized. As it is necessary to have a frequency or wavelength standard from which to work, such a standard must be built or purchased. A simple method for calibrating a home-constructed unit is to use the tuned circuit as an absorption trap in conjunction with a regular radio set, setting the eventual wavemeter so that it "tunes out" the carrier of a broadcast station using crystal control; these stations can be depended upon to be adjusted to their assigned frequency. Once the dial readings for these frequencies have been determined, the rough calibration of a "wavemeter" has been accomplished. Plotting these values on graph paper will supply intermediate values.

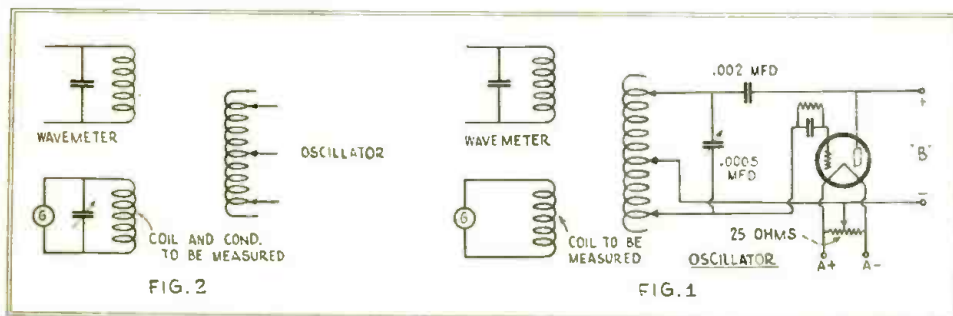

The two schematic arrangements above indicate the proper connections and coil relations to be observed when determining the wavelength range of a particular coil, or coil-and-condenser.

can be obtained from tables and the use of formulas, but for real accurate results it is impossible to obtain the information without some laboratory testing apparatus.

Most every radio fan has an oscillator and a wave meter. If you have a calibrated oscillator, it will be much better.

A neat and accurate galvanometer can be made for a few cents by winding a few turns of fine wire on a form one inch square. Hang this solenoid between the poles of a horseshoe magnet, allowing the ends of the coil to support it.

Place the galvanometer across the ends of the coil to be measured, Fig. 1, and bring the coil in close proximity to the coil of the oscillator. Rotate the dial of the oscillator until there is resonance between the two coils. When the wavelength of the oscillator is the same as that of the coil to be measured a current will be noted to flow in the galvanometer. The indication may be very slight. The amount of deflection of the galvanometer depends upon its sensitivity and the coupling of the two coils. If your oscillator is calibrated the fundamental wavelength can be read right from the curve.

If your oscillator is not calibrated it will be necessary to employ a wavemeter to get the wavelength of your coil. This can be done by bringing your wavemeter (absorption type) close to the coil to be

"B" plus to plate. Otherwise, the battery resistance would probably be so low there would not be sufficient radio frequency voltage drop to cause circuit oscillation. This choke may be of any convenient size. On an ordinary thread spool, 250 turns of 30 to 36 gauge wire with almost any kind of insulation would work well.

It must be noted that incorrect coupling of the absorption circuit to the circuit under test will result in double hump resonance,—the indicating device will register at two different wave lengths quite close together. To remedy this it is only necessary to loosen the coupling until the two resonance points merge into one. (It might be of interest to point out that this phenomenon is harnessed to furnish the circuit selectivity of the Hammarlund Hi-Q29 receiver, where the coupling has been reduced to one per cent.)

Instead of the 25-ohm potentiometer diagrammed, it is suggested that a 300- or 400-ohm one be used if a battery type tube is used rather than one of the A.C. type.

Also, the oscillator may work more smoothly if the grid leak connects to filament of the tube. The negative "A" is the correct side for an oscillator.

The .002 mfd. fixed condenser must be of high grade as the "B" potential is impressed on it at all times.

PLACING SCREWS

TWO means to place screws in not easily accessible places are illustrated. In (a), the use of paper is indicated. It may be necessary to double the paper in order to wedge it into the slot with sufficient resistance to hold the screw during placement.

The design of a special tool is illustrated in (b). It consists of two pieces of spring material with the requisite thinness at the ends. The two pieces are recessed into a piece of rod. It makes a very handy tool.

If standard screws are to be used in any considerable quantity, it may be convenient to file the tip of an old screwdriver so it tightly fits the slot of the particular screw used.

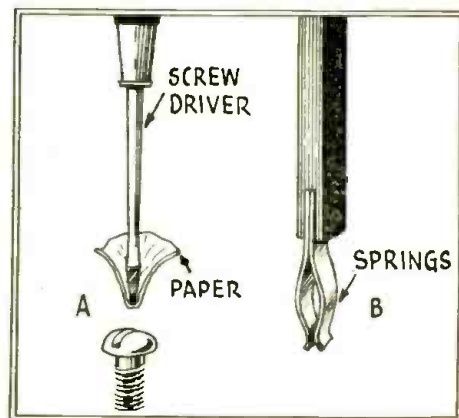

In addition to the two ideas outlined above for placing screws in almost inaccessible places, there is the method of using a piece of wood whittled to fit the slot in the head of the screw.

NOVEL 3-CIRCUIT TUNER

By Louis B. Sklar

A DESIGN for a coil of the tuned radio-frequency type and having an adjustable primary to compensate for various lengths of aerials."

That single sentence tells almost the entire story.

For those who want details it may be mentioned that the construction of the coil is extremely simple and it may easily be made from odds and ends about the work-shop. The sketch shows the coil assembly, but it does not show any specific dimensions, as they are not necessary. It is only necessary that the primary coil be small enough in size to slip easily into and out of the secondary.

The number of turns on the secondary depends of course on the size of the tube on which it is wound and the frequencies which it is desired to cover; these data may be obtained from various sources. Usually, with these data for the secondary, the number of turns for the primary is also given where the primary is to be wound on the same tube. In this case, however, the primary is wound on a smaller sized tube and may also be moved away from the secondary, both conditions reducing the inductive coupling between primary and secondary. To offset these conditions it is therefore recommended that about twice as many turns be wound on the primary as would be the case if the primary were wound on the same tube as the secondary.

The primary coil is supported as shown by a piece of ordinary bus-bar, which is bent into the shape of a curve and operates through a binding post of the thumb-screw type. When the primary is moved as far as possible away from the secondary it is also then at right angles to the secondary, because of the curve in the bus-bar. Thus it is adjustable through the entire range from maximum to minimum coupling, and provides a gradual variation in coupling impossible to obtain with primaries of the tapped variety.

The author worked out this design, about a month ago, winding the secondary on a 2-inch tube for the broadcast frequencies. A coil similar to the primary was mounted on the opposite end of the secondary as a tickler coil, the feedback control being a midget condenser. The result was a home-made 3-circuit

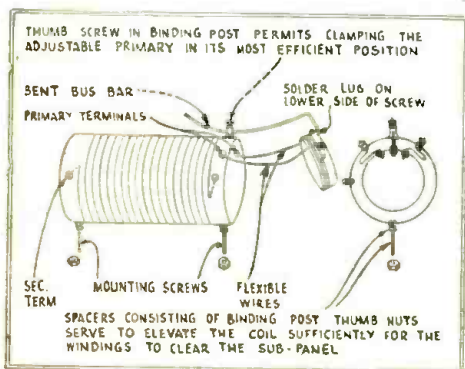

A novel coupling arrangement.

tuner which, in tests, proved to be superior to a high priced and well known factory made tuner.

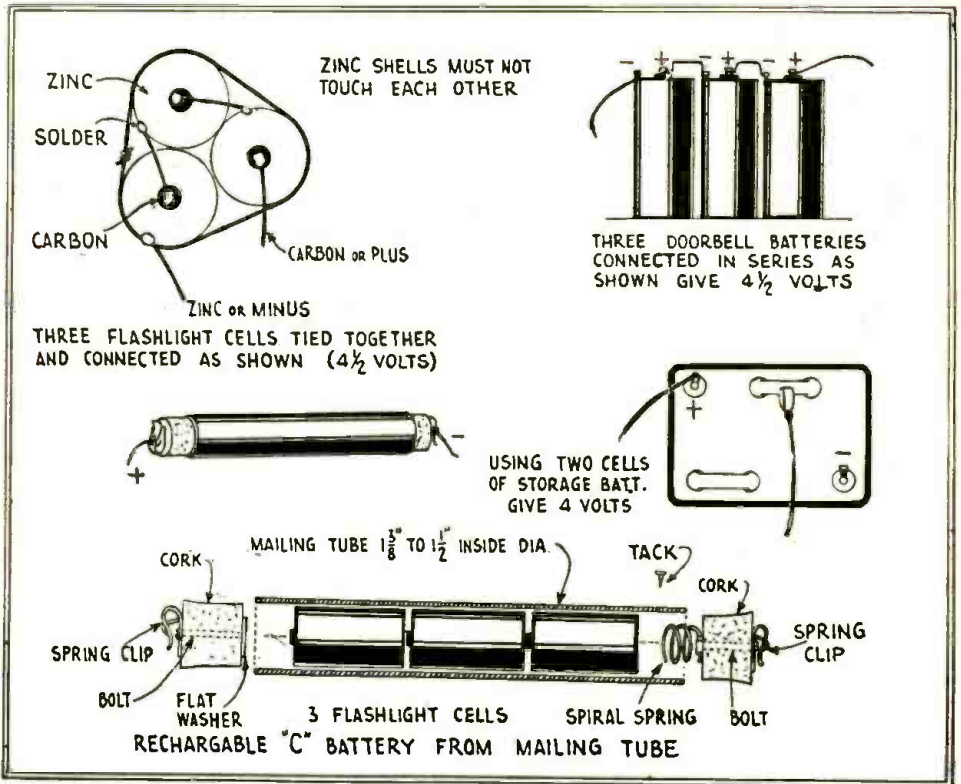

These sketches remove any doubts which may have existed as to the correct way to connect individual cells to form a battery having a potential of 4 1/2 volts.

SELECTIVITY UNIT

A CONVENIENT mounting for the variable condenser (at right) in series with the antenna, may serve a great many purposes. In the average receiver, it acts as volume, selectivity, and dial balancing unit.

Its size is determined by individual conditions. In the particular instance recorded it was a Precise Midget of 135 mmf. capacity, maximum.

Arrow on knob top indicates relative maximum to minimum capacity settings in relation to two black dots put on the aluminum shell.

If desired, a switch may be mounted on the same base and wired to short out the variable condenser with one throw of the blade and put it in operation with the other.

The wires from the variable condenser are led through V-shaped grooves clipped in the aluminum with pliers.

CHEAP HOMEMADE "C" BATTERIES

By L. B. Robbins

THE radio fan can build his own "C" batteries for about half the price of the commercial kind by using flashlight cells, a piece of mailing tube and odds and ends lying about the bench.

Cut off a piece of heavy mailing tube about eight and one-half inches long and just large enough to take a flashlight battery cell inside without too much play. Then procure two large corks to fit in the tube. Drill a hole down through the center of each. Push a flat headed brass bolt through one so the head bears against the small end. Fit a Fahnestock clip over the projecting end and thread on a nut. This is the positive plug. Wind three or four turns of stiff brass wire as a spiral spring and fasten under the head of the bolt in the second cork and a Fahnestock under the nut of this bolt

for the negative plug. Wind wire on the tube ends to prevent it expanding.

Fill the tube with three cells (4 1/2 volts) laid top to bottom in series. Push the spring plug in against the zinc bottom of one end cell and the bolt head against the carbon contact of the other. Then push a small tack through the tube into each cork to hold them in place and the battery is finished. Connect the lead wires to the clips. This can be refilled for thirty cents when run down.

An emergency 4 1/2 volt "C" battery can also be made from three flashlight cells as shown. Tie three insulated cells together with stout cord, reversing the ends of one of them. Then solder a wire to the center tap of one to the zinc bottom of the second and another wire from the center tap of the second to the zinc bottom of the third. Two lead wires can then be soldered from the remaining opposite faces of the first and third.

Three ordinary dry cells can be connected in series to act as a "C" battery in the manner also shown.

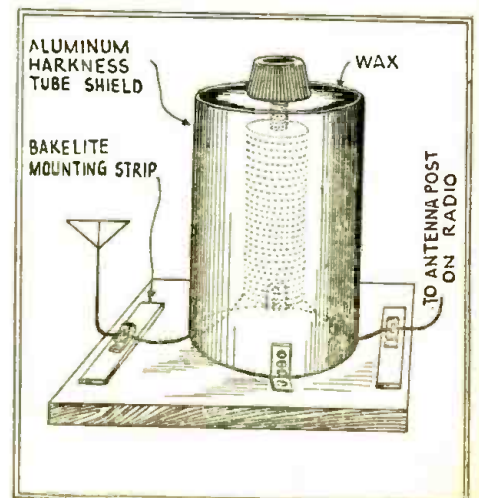

Mounting the antenna series condenser.



The Adelman Universal Tester

With a few inexpensive parts properly arranged, anyone can have a test instrument of great convenience and completeness.

By LEON L. ADELMAN, A. M. I. R. E.*

SOME time ago the author, in collaboration with Mr. A. R. Marcy, Chief Engineer of station WFBL, evolved a circuit using a single meter to meet the demands normally imposed on three or more meters. Results greatly exceeded expectations.

While at the present time there is an almost endless assortment of meters of all types available to the radio craftsman, it is seldom that two or more functions are incorporated in a single meter.

In the few instances where an attempt has been made to combine several functions with a minimum of instruments, the cost has been extremely high.

For these reasons, as well as the portability and flexibility of the device, this unit will appeal to radio craftsmen in all branches of the art.

* Chief Engineer, A. M. Flechtheim & Co., Inc.

What the Meter Will Do

The instrument is small, compact and presents a really beautiful appearance in its well-finished cabinet. Exceedingly portable, and solidly built, it may be carried from place to place without fear of damage.

A major classification of the functions of the unit follows:

1. Voltage tester: for "A", "B", "C" batteries and for "A", "B", "C" eliminators and trickle chargers.

2. Tube tester: measures the direct plate current consumption of the tube in a circuit oscillating at radio frequency, and thus gives the actual efficiency of the tube in a relative way.

3. Circuit tester: for open, shorted and grounded circuits on coils, condensers, transformers, choke coils, rheostats, loud speakers, etc.

The large number of trouble-shooting



The completed Tester. The test prods and wire shown are standard equipment in all shops and service men's kits. The carrying case may be arranged to tilt, if desired.

cases in which the meter will find endless use, is really surprising, for though the subject of trouble shooting is a rather large one, it is quite possible to give an accurate outline of the most general cases.

Then again, the testing procedure involved in obtaining the characteristics of vacuum tubes in order to ascertain the particular use for which the tubes are best suited has been boiled down to a very simple method which has been found to be infallible.

Of course, where the laboratory requirements are exacting and severe, it is advisable to use the 'round-about method of finding the amplification constant, the plate impedance, the mutual conductance and other important characteristics.

In other words, the meter described in the following paragraphs gives only the information which would be required by the practitioner and not by the laboratory engineer who is anxious to find out the number of electrons which leave the filament every second, or to learn the extent of electrolysis taking place in the glass hulk when the tube is operating at definite voltages and frequencies. What it does do, (it answers the purpose very nicely) is given in abstract terms—2, 3, 4, 5 or more, the exact relative values of the tube and denotes its particular use as an amplifier for radio or audio frequencies, or as a detector.

Any type of tube can be tested—the '99 type, the '01A, the '12, the '71. Below is the list of parts required for its construction.

List of Parts

1—Micarta Panel $7\frac{3}{4}$ x $6\frac{1}{16}$ x $\frac{1}{8}$ inch

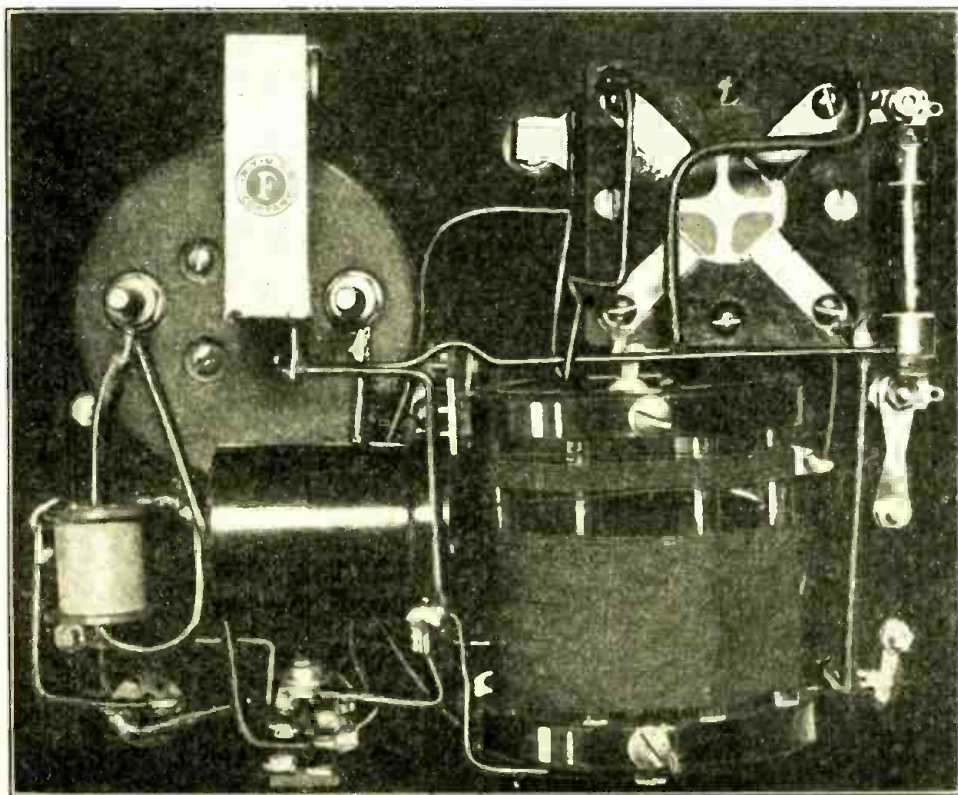

Interior view of the Service Man's stand-by, the combination meter. In this instrument, all the possibilities of the instrument are realized with a minimum of construction or control complications. Standard equipment is utilized throughout.

fluctuations in the supply can be noted quite readily.

In this manner, "A", "B", and "C" voltages from batteries or eliminators can be ascertained with accuracy. However, make sure that you do not reverse the polarities of the voltage supply leads

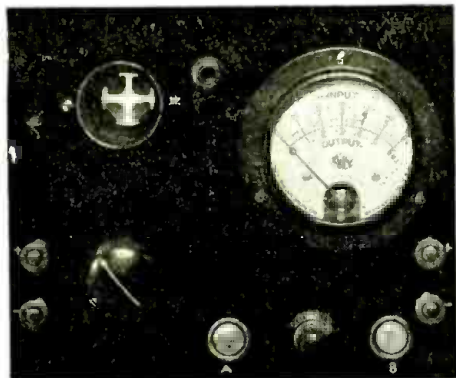

The way the panel appears. All the instruments are mounted on this panel, making the unit independent of the carrying case.

to the terminals. The author finds that the needle pointer develops a powerful kick which results in a badly bent pointer. The marked leads of the cords plainly show the polarity and should not be disregarded or forgotten when making connections. Remember,—it requires one single mistake to undo plenty of time and labor.

Since the meter has full scale deflection of 6 volts and 6 milliamperes, it is easy to understand that at 6 volts, the meter consumes 6 milliamperes and thus the resistance of the meter must be 1000 ohms.

Following the same line of thought, the resistance of the multiplier, in order that the full scale reading of the meter be 120 volts, is 19,000 ohms.

It will be seen therefore, that the meter consumes very little current and is thus capable of giving a very accurate measure of the voltage output of an eliminator or trickle charger.

How to Test Tubes

Tubes can be tested quickly, accurately and safely. Let us first consider the type '99. First, connect a source of filament supply to the "A" terminals on the tester. Either 4 or 6 volts can be used. However, be sure that the rheostat is in the "off" position.

Keep in mind to use 45 volts on the plate of the tubes when testing them. If a higher potential is employed, say 90 volts, the tube may be found to be so exceptionally good, when tested for radio frequency oscillations, that the needle of the meter may go off the scale. Besides, the curves plotted for tubes with 45 volts on the plate will, of course, be different from those using 90 volts. (For the type '71 tube, use only 22½ volts.)

Therefore, connect 45 volts of "B" battery potential to the "B" terminals. Place the tube in the socket. (Use an adapter, if it is the old type.) Then turn on the rheostat slowly, keeping your finger pressed down on the "A" push button and with your eyes on the pointer of the meter. You will notice the needle start to move very slowly at first and

then accelerate with every small increment in filament voltage. Stop turning the rheostat when the needle points to 3.3 volts, for that is the proper filament operating potential for '99 type tubes. Then take your finger off the "A" push button and press the "B" push button, merely to ascertain the proper plate voltage for the tube. When the upper scale of the meter has been read and found to be 45 volts, the direct current input requirements of the tube have been met with. The grid return of the tube has been made to the negative side of the "A" battery, making the circuit more adaptable to oscillation.

It will be noticed that no grid leak and grid condenser are used, nor even a by-pass condenser across the secondary of the radio frequency inductance.

Now when it has been ascertained that the tube is properly fed with the required voltages, do not touch anything else, but turn the cam switch to its "on" position. Note the meter reading. It should be anywhere from 1.5 to 2.5 milliamperes for the '99 type of tube.

If the reading is very low, the tube is evidently a poor one and should not be used as radio frequency amplifier or detector. Even as an audio frequency amplifier it may not function with much success, but if it must be used, it should be placed in the audio frequency amplifier circuit, preferably the first stage.

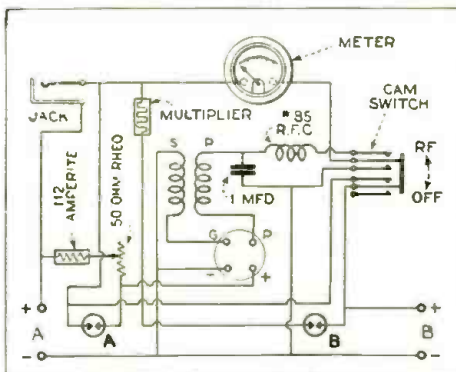

Schematic circuit of the Adelman Universal Tester. Note the simplicity of the wiring.

However, the low reading may be due to the fact that the circuit is not oscillating. This condition may result from an improper connection of the plate coil in the oscillatory circuit. Try reversing the leads to the plate coil and then take the R.F. reading. Whether the circuit is oscillating can quickly be determined by placing a finger on the grid terminal of the inductance coil or socket. The meter reading should fall off appreciably when the finger is placed on this high potential post. If it doesn't, then one can be reasonably sure that the tube circuit is not oscillating.

Effect of Filament Increase

One thing must be kept in mind, and that is:—it is possible to increase the R.F. reading slightly by increasing the filament potential.

Yet, it must also be remembered that an increase of 10 per cent in filament potential results in a marked decrease in the life of a tube. Thus, if the filament potential is adjusted to 5.5 volts

for a type '01A tube, it may be found that the plate current can be increased half again, or more than when operating the tube at 5 volts.

If, therefore, it is desired to use a certain tube in a receiver to obtain the best results, it may be necessary to adjust the filament rheostat. Unless the tube is controlled by a separate rheostat, the other tubes may suffer because of the overloaded condition under which they are forced to operate. This results in a distinct loss, for the tubes soon lose their efficiency and the reproduction from the receiver is affected.

When, of course, the tube is controlled by an automatic filament device like an amperite, sufficient volume or amplification may not be obtained because the emission from the filament is too low. Hence, the best place for such a tube is in the first stage of audio amplification, after which a stage of power amplification can be used.

The radio frequency choke coil and by-pass condenser augment the chances for self-oscillation in the circuit and keep the radio frequency currents out of the meter and batteries. This insures accurate tube characteristic readings.

The wave-length at which the tube circuit is made to oscillate is approximately 130 meters. The inductance of the secondary winding together with its self or distributed capacity, which is extremely low because of the exceptionally fine construction and design of the coil, afford the high frequency conditions, (about 2,300,000 cycles) at which the tube responds. As this value of oscillation is far greater than that at which the tube will be called upon for any broadcast range reception, the tube is tested in a manner that is positive and thoroughly definite in every respect.

Another important thing to keep in mind is that there are a number of tubes at present on the market which, although giving a large plate current reading, are really short-lived because the filament emission decreases quite abruptly soon after the tube is placed in operation. Thus, care should be exercised when purchasing them.

Since the meter range is but 6 mils., and since the type '12 tube makes a very good detector tube when operated at the proper point on its characteristic curve, do not connect 90 volts of plate current to test the tube, because the needle pointer of the meter may run off the scale and be badly bent. Very often a good detector will operate very efficiently as an audio amplifier.

Here is a chart which gives all the information concerning the tubes most generally used and what should be expected from them when tested with the meter.

Type	Plate Potential of 45 Volts			Input Characteristics Filament Volts Amps.
	Poor	Good	Very Good	
199	1.50 M.A.	2.0 M.A.	2.5 M.A.	3.3 .06
200A	1.0	1.50	1.75	5.0 .25
'01A	3.50	4.0	4.50	5.0 .25
	5.0	5.75	6.0	5.0 .50
	3.0	3.25	3.50	5.0 .50

It will be noted that a 45-volt "B" potential has been used for testing all

* Use only 22½ volts when testing '71's.

the tubes, even though some require more and others less. However, the values of the R.F. readings as given in the above chart have taken this into consideration and represent the results of averaging together the readings found during the testing of a large number of the various types of tubes. Thus, one has the means of ascertaining the actual value of a tube and for what purpose it should be used in a radio receiver. Only "good" tubes should be employed as radio frequency amplifiers and detectors. The audio amplifier may use those found slightly below par.

No longer will the layman who wants to buy a tube or a set of them, have to listen to the man behind the counter proclaim in seemingly unintelligible terms the value of mutual conductance, amplification constant, plate impedance and what-not which really mean nothing to him. The meter can tell him—in one syllable—how good the tubes are!

A type '12 amperite has been incorporated in the circuit. This is used to provide the proper amount of filament potential when testing the type '12 and '71 tubes. Naturally, the rheostat arm is turned to its maximum position, so that no current will traverse the resistance wire. Otherwise, one-half ampere through the wire may burn it out.

How to Test a Radio Set

The experienced trouble shooter can often, by merely listening to the imperfect reproduction of a defective radio receiver, tell just what the trouble is due to. And often, too, he cannot tell unless he tries, first one thing, then another. Or again, if the tubes don't light, or there is no sound in the loud speaker, or one of the thousand and one possibilities of trouble manifest themselves, the Universal Tester finds immediate use and renders invaluable service, where it would be a matter of guess work otherwise. And wise service men don't guess.

A systematic method of procedure in testing a radio circuit is always the best. And, regardless of the type of circuit, the same general idea should be carried out.

First—Ascertain whether the source of current supply to the receiver is proper and of accurate voltage. Test either the batteries or eliminator or both, as the case may be. The meter will tell readily whether the "A" battery is down, or the "B" eliminator is defective or whether the supply is functioning perfectly.

Second—The tubes should next be tested. A visual inspection of the tube prongs and socket contacts is not amiss and should be made. Take no chances with the seemingly little things. They are the big things in a radio set.

Third—Turn the receiver "on" and disconnect one terminal of the loud speaker. The connection should be made and broken a few times. If a loud click is audible, then, since no signals are reproduced, there must be something wrong with the wiring of the set. Possibly a connection is broken. If there is no loud click in the speaker, there is room for further complications, such as a broken

AN OPEN REQUEST

TO all those who test radio equipment: Let us know what method you find is the most satisfactory for rapidly locating faults in radio sets or parts. Let us know what is your "continuity test" for average sets.

All accepted material will be paid for at space rates and the *three most INSTRUCTIVE* articles will be paid for at *triple* space rates!

So, let's go, fellows!

Address your replies to:

The Radio Service Man, care of
Radio-Craft Magazine, 98 Park Place,
New York City.

cord lead or a burnt-out speaker. But, we shall see, we shall see.

Before taking the set out of its cabinet, see that the antenna and ground connections are good. Also, test the current supply voltages at the binding posts on the receiver itself, to check the possibility of trouble due to broken battery supply leads. When these precautionary tests have failed to coax the set into operation, and further maledictory comment is of no avail, take the chassis gently out of its cabinet. Of course, give the tubes the air, *i.e.*, put them out of harm's way.

To the man who knows radio, not all sets and their faults are alike. This means that what is a peculiar ailment for one type of set, is not at all common to another. Thus, give the set a thorough visual inspection to see that there are no broken leads or loose connections. See to it that the variable condenser plates do not touch at any setting of the condenser, but that the plates are evenly and uniformly centered over the entire range. Blow off all the dust.

The visual inspection therefore, as you can readily surmise, is to locate mechanical trouble with a radio set. Even a short-circuit is classed under this heading, for a mechanical accident is no doubt responsible for an electrical discrepancy.

Connect an "A" battery or, if not available, the source of "A" battery voltage used by the receiver, to the "A" terminals of the meter. Then plug in the trusty jack and momentarily touch the long flexible wire leads together. If a full scale deflection is obtained, then everything is "Jake". Remember that a full scale deflection means six milliamperes through the meter. (Quite sensitive, and enough for all practical purposes.)

Additional Checks

The audio frequency transformers should be tested first. The primary and secondary readings are taken. By comparing these readings, it will be possible to obtain in a fair manner the ratio of the transformer. No reading, indicates an open circuit,—a burnout. A full scale deflection indicates a primary or secondary short-circuit internally or, more presumably, externally. It is possible that the leads from the transformer are touching, or a fixed condenser across the winding may be defective. Test the windings for a ground and for inter-connection between them. Only when no

"C" battery connections are used and the grid return is made directly to minus "A," and only when that terminal is grounded, should one get a full scale reading. Full working knowledge of the circuit facilitates this test, for it takes longer to describe than to make.

All the fixed condensers (grid, by-pass and filter), should be tested next for shorts and grounds. If a sudden but very slight deflection is noted when testing fixed condensers, it should be borne in mind that the phenomenon is merely the condenser becoming charged. Allowance should be made for the reading of the meter when a condenser which is connected in the circuit across the primary of an audio transformer is tested. Yet, if the reading is anything but what may be expected, ascertain the condition carefully, before jumping to conclusions.

The direct current resistance of radio frequency inductances is practically negligible, hence the meter will read full scale when the primaries and secondaries of these units are tested. Should no reading be manifest, then look at the leads. They may be broken, even though the insulation remains intact. This is one of the most exasperating types of troubles. Offset the chances for trouble of this baffling nature by testing the plate and grid circuits and filament circuit by holding one terminal of the meter lead on the tube binding post of the circuit to be traced. Thus, for example, there should be a reading from the plate post on the first, second and (if there be one) third radio frequency amplifier tube to the plate "B" minus or "A" voltage binding post or connection.

Should there be a radio frequency choke coil connected in series, consideration of the voltage drop across the coil will explain the fact that the meter does not give a full scale deflection.

The plate circuit of the detector tube has the primary of the first audio transformer in circuit with it and hence the reading will be in accordance with the resistance of the primary. Should there be a high resistance in the circuit instead of the transformer, as in a resistance-coupled amplifier circuit, no reading will be had.

One of the most troublesome sources of difficulty is the cold-soldered joint which very often appears to be a perfect connection but is in reality a high resistance contact. The troubles arising therefrom are very hard to remedy, especially when the joints are overlooked in the hasty visual inspection given a receiver. It is therefore stressed that all connections be tried and yanked a bit to see whether the wire is loose.

Corrosion at junctures takes place when acid flux is employed in wiring the set and this evil too, takes its toll eventually. So aside from the meter test, one must rely upon the visual inspection to help locate trouble.

There can be no doubt as to the efficacy of the meter test, though the human element plays an important part in determining "what seems to ail the radio set". Many a radio set may be salvaged from the ash can to which it has been or is about to be relegated, and fixed up to continue to do its part in elevating and enlightening our civilization, for the benefit of mankind.

The Cooperative Radio Laboratory

Where all experimenters may meet on a common ground to discuss and develop radio technicalities.

DAVID GRIMES, Director

With this article by Mr. David Grimes, known affectionately to his friends as "Reflex" Grimes, we take great pleasure in presenting the first of a series of articles written expressly for the experimenter, by a distinguished experimenter.

It has been said that "two heads are better than one," and therefore, "thousands—." Well, it is believed that a cooperative laboratory, a sort of mutual proving ground, can do more in a short time to advance the art than the same amount of effort expended individually where each experimenter may be duplicating the work of others. This is the opinion of Mr. Grimes and we concur with him.

We welcome every honest-to-goodness experimenter to The Cooperative Radio Laboratory; we invite your criticisms, suggestions, ideas, questions and cooperation, just as though we were all together under one big roof, with a lot of experimental equipment, a problem, and Professor David Grimes before us to say, "Let's go!"

AN experimenter is always interested in investigating along development lines that have either been long dormant or have remained undiscovered. So an experimenter's laboratory is usually cluttered up with all sorts of test equipment designed for supposedly improving the art. In this respect, radio is no exception. During the past three years, the industry has so advanced that even an experimenter has great difficulty in keeping up with the procession.

We have developed real power amplifiers and power speakers. New band-pass filters have found their way into commercial set design. Alternating current and screen grid tubes are now generally employed in radio receiving. In fact, every conceivable improvement, seemingly within the bounds of possibility, has been added to radio and audio frequency circuits and the associated loud speaker.

High Quality Detector

Now, the amazing thing about this entire program is the fact that one essen-

tial item in this picture has been left almost alone and forgotten. The problem of high quality detection has hardly been touched! Now and then, one does hear something about power detection, but that is about as far as it goes.

The old familiar grid leak system of detection is the one in general use, today—yet it has only one thing to recommend it. It is very sensitive and that's all. It has nothing else to add to and much to subtract from good modern reproduction. For good quality on powerful medium range or local stations, it just isn't there! Now, what is accomplished by high quality audio amplification and dynamic speaker attachments, if the tone quality is ruined right at the very start—in the detector circuit, itself?

We believe that the detector calls for more serious thought than all other associated circuits combined. It is really amazing what can be done with good detection, even when employing mediocre amplifying circuits and reproducers. So, let us concentrate for a few months on the detector problem. It will be well

condenser chokes up faster than the grid leak can possibly discharge it. The strong carrier wave thus builds up a

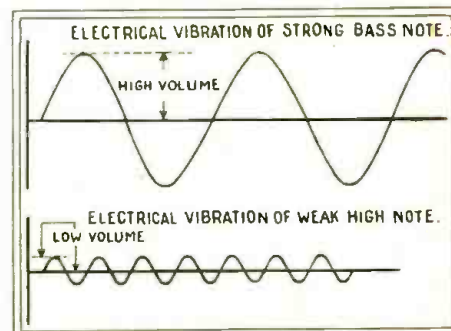

Fig. 2. This graph clearly shows the relation between high and low volumes, and fast or slow motion. The central, horizontal line represents "time."

negative charge on the grid through accumulated electrons. This negative grid bias cuts the plate current to practically a zero value. Reference should here be made to Figure 1 which shows the conventional grid leak detector and first audio stage.

It is obvious that, if all plate current were shut off in the detector tube, there could not possibly be any detector action nor any resulting signals in the audio amplifying system. Under such an extreme condition, the detector grid would be completely choked. Rarely does this occur in actual practice. However, poor quality is very noticeable long before this point is reached. This poor quality is distinguishable by a total loss of the lower, or bass, notes. The higher register persists up to the end.

While it is a little aside from the point, we believe it sufficiently important to offer an explanation of this low note discrimination on the part of an overloaded grid leak detector. This involves the theory of musical mechanics. One has but to refer to his piano to find that the low tones are produced by the longest and heaviest strings—high notes by the thin, short, tightly stretched wires. A touch of the finger on the strings will reveal that the long heavy strings vibrate much farther and more energetically, when played, than the higher tones. Keep this very fundamental fact always in mind.

Power in Low Notes

Now, the alternating currents in an electrical circuit, which represent the various musical tones, behave exactly like the musical vibrations, themselves; because they are created by those tones. Hence, we find that the low bass notes are represented by very strong, energetic electrical currents and the higher notes are represented by very weak currents. Reference should here be made to Figure 2.

A normally operating grid leak detec-

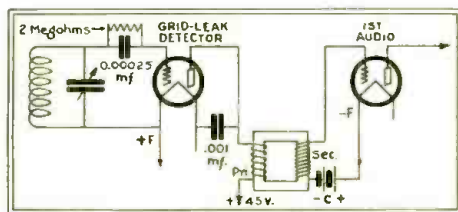

Fig. 1. This is the conventional grid leak, grid condenser circuit concerning which there has been much talk, but it still is almost impossible to get two people to agree on the cause of certain phenomena observable when using this type of rectification.

worth while—time well spent and money saved. And by way of introduction, let us state that it is our object, in conducting this department, to give such information as will enable you to obtain maximum results at a minimum cost. In this way, you will be able to afford more experimentation.

The grid leak detector results in poor quality on loud signals because the grid

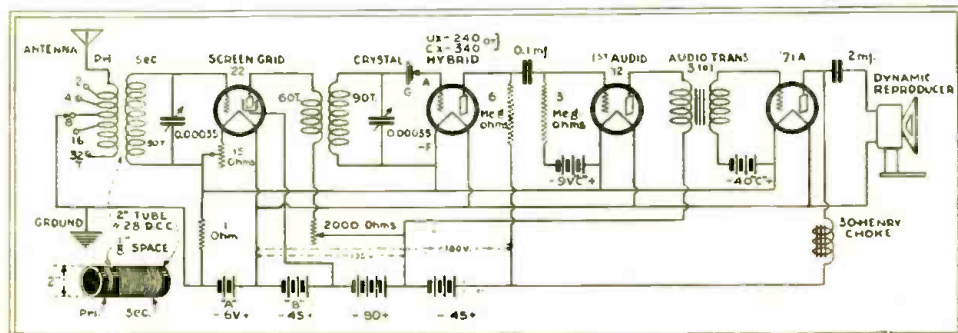

Fig. 5. Complete schematic circuit showing correct constants for proper operation of the carborundum crystal and the hybrid tube. Note the particularly high resistance in the plate circuit of the hybrid tube. By-pass condensers may be needed across the "B" connections, to prevent the effects of internal resistance.

tor has sufficient plate current to pass both the energetic low tones and, of course, the weak high ones. But, as soon as the plate current is somewhat reduced by the grid choking up with electrons, it is no longer adequate to handle the larger electrical vibrations (the low tones), although it continues to pass the weaker electrical vibrations (the high tones) quite satisfactorily. It is thus very easy to see that low notes are immediately sacrificed upon overloading a grid leak detector; and bass is what we have all been seeking. Again we ask, why have good audio amplifiers and reproducers if we choke out our real tone quality at the detector?

It was to overcome these troubles that the "C" battery detector, or plate rectifying system, was widely advocated. Figure 3 shows the "C" battery detector arrangement. This principle does away with all grid choking—in fact, the louder the station, the better the tone quality, as the plate current actually increases and more of the heavy bass vibrations can pass into the first audio stage. The "C" battery detector has one serious drawback—it is relatively insensitive when compared with the grid leak type.

It would almost appear that there are no satisfactory compromise detector possibilities. We must either have distance with poor local quality or less distance with good quality. But, fortunately, such is not the case. The old lowly crystal comes to the rescue! Yes, the same old crystal detector that we threw away in disgust in years gone by. Of course, even it has been improved and new circuit arrangements conceived.

Carborundum

Crystal detectors, in the past, have been famous for their many different ways of giving dissatisfaction; so don't throw up your hands and walk out on us before you've heard our story. We, ourselves, know a thing or two about crystals and our answer to this is: there are crystals and crystals. Crystal detectors have been noted, in particular for their instability, short life, critical adjustment, insensitiveness, broad tuning, and what have you? It will interest you to know that most of these shortcomings are not in the least attributable to the crystal. The associated circuits are mostly to blame. The questions of instability and critical adjustment have been most satisfactorily answered by the new semi-adjustable Carborundum detector.

Of course, Carborundum has been recognized for a long time as a very stable crystal rectifier. Born in the electric furnace, its ruggedness might be termed a birthright. It was used on ships in the days before wireless became known as radio. The necessary pressure to insure the proper operation of the Carborundum did away with the well remembered critical catswhisker. The other disadvantages, however, remained to continually harass the crystal enthusiast until Mr. Hugo Gernsback introduced the ideal crystal circuit over three years ago. This was so superior to anything of its kind that it worked wonders in spite of the relatively poor audio circuits and loud speakers then

IN this new series, Mr. Grimes takes hold of the INTERFLEX principle. This principle was propounded by Mr. H. Gernsback in the September, 1925, issue of *Radio News*.

Mr. Grimes has added many new thoughts to the original INTERFLEX idea and his findings make excellent reading.

As Mr. Gernsback pointed out in his original articles, there is nothing that can equal the INTERFLEX principle, that is, the crystal-tube combination for quality in reproduction.

We hope we have many more interesting articles by Mr. Grimes.

available. The tone quality created at the crystal was better than could be properly handled by the rest of the receiver. Thousands upon thousands of experimenters built that circuit and are still using it in preference to anything else. This really new crystal circuit was called the Interflex. This is simply shown in Figure 4.

The reason for all of our present enthusiasm is the combination of this

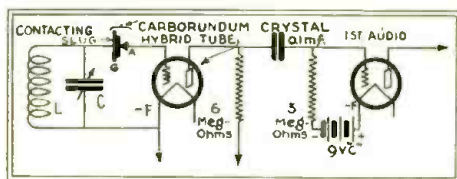

Fig. 4. The "Interflex." as the original crystal-tube circuit was called by its inventor, Mr. Hugo Gernsback. This circuit aroused international interest when it first appeared and subsequent variations were followed closely.

crystal circuit with new types of resistance and transformer coupling and modern dynamic reproducers that will properly handle the real tone quality created. We have decided to call this new arrangement the hybrid-crystal circuit. Such a name is somewhat descriptive of its operation and, therefore, is easily remembered. Hybrid, according to the best dictionaries, means a mixed combination of things—and we are certainly mixing the functions of the tube and crystal. Figure 5 gives a suggested over-all four tube circuit, employing D.C. tubes, with a UX-222 or CX-322 screen grid for the R.F. stage.

At first glance, you will note many peculiarities in the hook-up. The semi-adjustable Carborundum crystal is connected in that portion of the circuit nor-

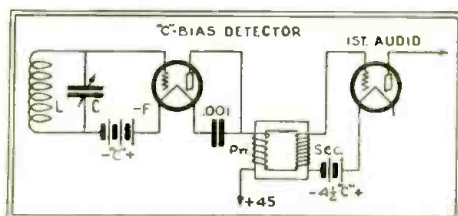

Fig. 3. The "grid bias detector." The stronger the signals, the better this arrangement works. A strong signal being "handled" without great distortion.

mally occupied by the grid-leak and condenser. Yet, a minus grid return is absolutely necessary; while, with a grid-leak, a plus return is much to be pre-

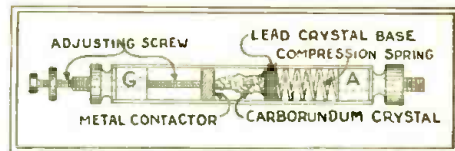

Fig. 6. This illustrates the construction details of the carborundum cartridge found most satisfactory in the several circuits shown and to appear in later issues of *Radio-Craft* magazine.

ferred. Next, the crystal must be connected in the circuit in a certain direction. The full technical explanation of this has yet to be offered. Anyway, by all means, try reversing the connections to the crystal for best results. The crystal, itself, must be connected to the grid of the tube, while the contactor is connected to the tuned circuit. On the outside circular case of the crystal unit, the crystal end is marked by the letter "A." The contactor end is marked by the letter "G." Figure 6 shows the construction of the semi-adjustable carborundum crystal with the above letters at their respective terminals.

The next interesting fact is that no plate blocking condenser is required in the hybrid tube—such as is customary in the plate circuits of detectors. You will recall that this blocking condenser is connected between the plate and filament and has a value of .001 Mf. capacity. The use of the crystal in the grid of the tube does away with this condenser entirely. Nothing is gained by its insertion and an undesirable reduction in the high notes results.

Perhaps more comment has resulted from the unusually-high resistance coupling than from any other part of the circuit. The six megohms in the plate circuit and three megohms in the grid circuit are so contrary to standard practice that you would probably suspect it was an error in the diagram, if your attention were not called to it. There is quite an interesting technical side to this resistance design which we will go into at some length in a subsequent article. Now, suffice it to say that the six megohms in the plate circuit are correct, that almost the full voltage amplification of the tube is available, and that the bass notes are brought in with a vigor that will surprise you. Neither the plate nor the grid resistor is critical as long as the coupling condenser is about 0.1 Mf. The plate resistor may be reduced to two megohms and the grid resistor may be anything from two to four megohms without very adversely affecting the tone quality. Keeping the plate resistor value near six megohms, however, greatly reduces the tendency for the circuit to howl.

Audio Coupling

Resistance coupling may be used in both audio stages; for greater volume use a transformer in the second stage. The transformer has been shown in the preliminary hook-up in Figure 5. Furthermore, two resistance stages sometimes motorboat on certain "B" eliminators; while the second stage transformer permits of a phase reversal to eliminate motorboating. This is accomplished by reversing the transformer primary connections to stop howling.

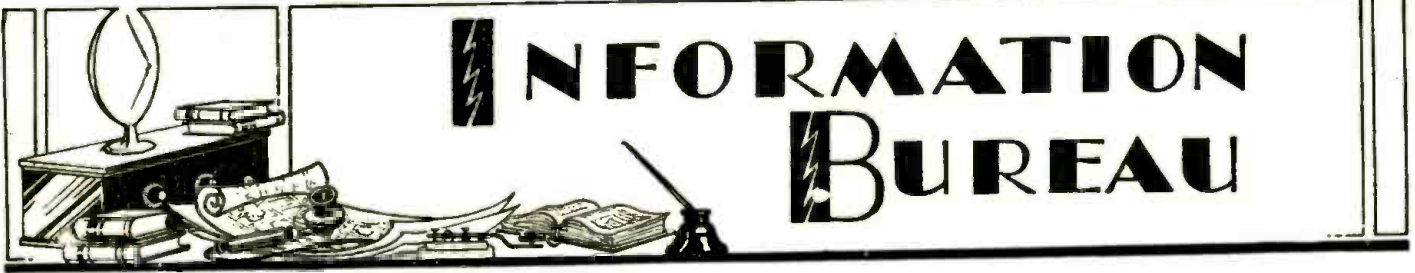

SPECIAL NOTICE

When writing to the Information Bureau, correspondents are requested to observe the following rules:

- (1) Ask as many questions as desired, but furnish sufficient information to permit a proper diagnosis. Carefully drawn schematic diagrams are often desirable.
- (2) Inquiries (not too involved) to be answered by mail must be accompanied by 25c in stamps, per single question. Blueprints are not available.
- (3) Use only one side of paper and LIST each question.
- (4) We cannot furnish comparisons between commercial instruments.

(The reader with the greatest number of interesting questions each month, although they may not all appear in the same issue, will find his name heading this department.)

Highest for the Month: THEODORE DUBRULE with 7 Interesting Questions

PUSH-PULL—BINAURAL RECEPTION

(10) Mr. J. K. Ellsworth, Minneapolis, Minn. (Q.) Please publish the schematic circuit of the Amertran "Type-2-AP" push-pull audio amplifier, using a single '27 and two '10 tubes, and the "B" eliminator designed for operation of these tubes.

(A.) The circuit of the Type-2-AP push-pull audio amplifier, and the Type-21-D "Hi-Power Box," designed to supply "A," "B" and "C" potentials, are shown in these columns.

The power unit supplies about 55 milliamperes at 450 volts for the power tubes, and about 25 milliamperes at lesser voltages for the radio set and the single '27 used in the audio box.

The two units are connected by a Yaxley 7-wire cable, which plugs into receptacles.

The units must be placed in proper relation to eliminate the possibility of hum. The audio should be located at the left of the power unit, and preferably six inches or more above it. Wrong "C" bias will cause hum; and a milliammeter should be plugged into the jack provided, to check the plate current on the various tubes. The '27 should read 3 ma. and the push-pull '10's should read 45 ma.

To compensate for line-voltage variation, a switch is provided to balance for any supply between 100 and 120 volts.

The current indicated when the milliammeter is plugged into the "sub-total" jack is the total output of the rectifier tubes exclusive of the plate current taken by the push-pull stage. This "sub-total" reading should not exceed 35 milliamperes.

The field winding of a dynamic speaker may be inserted between points X and Y, and an Amertran "Type-FD-16" resistor shunted from X to Z to increase the current through the voltage divider so that the "sub-total" value

is in the neighborhood of 40 to 50 milliamperes. There is a reduction of about 100 volts when a dynamic reproducer field is connected as described.

An Edison Mazda 14-volt toy-train lamp, rated at 170 ma., is in the high-voltage main circuit and, if a condenser should short-circuit, this lamp will act as a fuse.

The experimenter may use the following resistance values (see diagram) for "Bias-210," 2,000 ohms; "Bias," 1,000 ohms; "Voltage Divider," 41,000 ohms; "Det. Pl. Cur.," 100,000 ohms. Or, the following Ward Leonard units more accurate for the purpose may be used: "Bias 210," 2,250 ohms (Type 507-76); "Voltage Divider," 31,500 (Type Amertran 500); "Det. Pl. Cur.," 50,000 ohms (Type 507-85). The Amertran 500 resistance is in three sections. One side of the 7,500-ohm fixed resistor connects to the No. 854 choke and the 19,000-ohm resistor. The 19,000-ohm resistor has two variable taps. The 5,000-ohm resistor connects to the opposite end of the 19,000-ohm unit and to binding post "K."

The by-pass condensers are one mf. "Gnd.," the binding post connected to the metal base in front of the control panel, should be connected to ground, using a low-resistance lead. If "K" or "-A" is not grounded in the amplifier or tuner, connect "Gnd." binding post to "-filt." If "K" is grounded in the receiver, connect the terminal marked "K" to the binding post marked "Gnd." Ground either "K" or "-filt.," but not both.

It should be noted that this current supply unit furnishes a particularly complete range of "A," "B" and "C" voltages, and that there is but little likelihood of "motorboating," because of the (comparatively) very low resistance of the voltage-divider.

The audio-amplifier unit has a frequency characteristic, measured by N. E. M. A. stand-

ards, which shows no audible variation from a perfectly flat graph between the extremes of 50 cycles and 10,000 cycles.

The following table explains variations in the type numbers of these units:

Stage	Speaker	Output Trans.	A.F. Unit Type No.
'10	Mag.	152	2 AP-5
'10	Dyn.	200	2 AP-2
'71	Mag.	271	2 AP-7
'71	Dyn.	362	2 AP-6

Magnetic reproducers have an impedance between 2,000 and 4,000 ohms (such as the W. E. 560 AW). Dynamic reproducers (such as the Jensen and Magnavox) have an im-

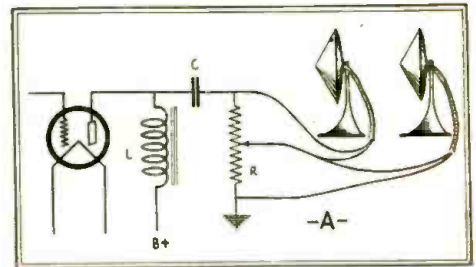

(Q. 10.) Using two similar reproducers to obtain a "binaural" effect.

pedance of 8 to 15 ohms, that of any reproducer depending upon the frequency.

"K Det." connects to the detector tube's filament, or cathode.

The A.F. unit weighs 20 pounds and the power unit weighs 50 pounds. The case of the A.F. amplifier should not be permitted to touch the case of the power supply.

(Q.) How can two loud speakers at oppo-

(Q. 10.) The Amertran Type 2-AP Audio Amplifier and Type 21-D "Hi-Power Box."

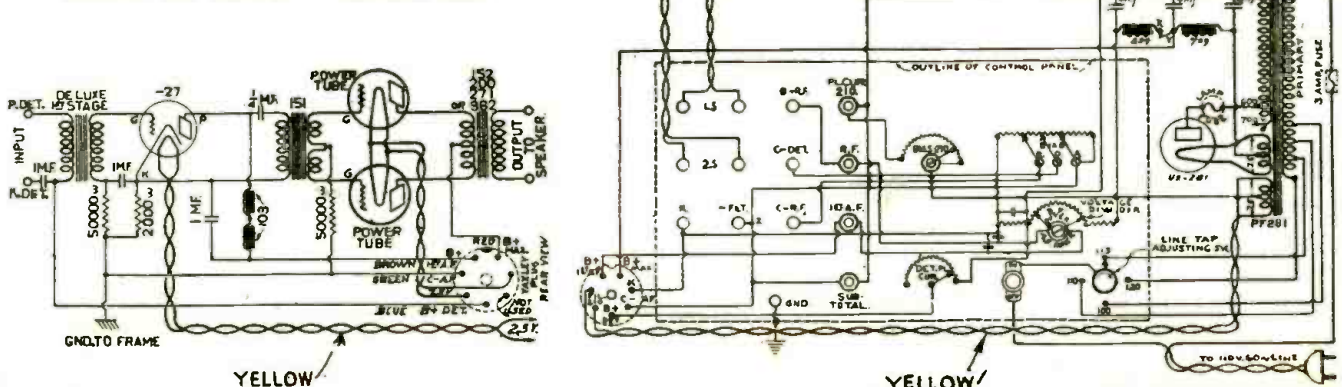

site ends of a room be wired and operated to produce a "binaural" effect? I have had the pleasure of listening to two reproducers, at a friend's house, connected this way. There did not seem to be any directional effect and, consequently, a realism resulted which seems quite unattainable with any other arrangement.

(A.) The circuit requested appears in these columns. At A, a 100,000-ohm potentiometer is shown; any other size may be used for experiment. If lower resistance is used, there will be a proportionate drop in the output volume. The setting of the potentiometer arm will depend upon the reproducers and the location of the listener; the listener should, preferably, be about half-way between the two repro-

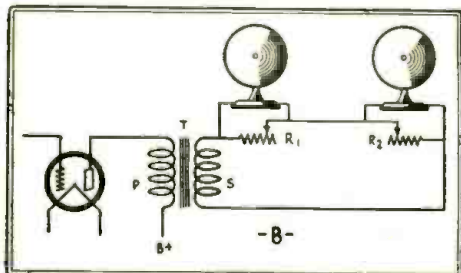

(Q. 10.) Another circuit arrangement for "binaural" reproduction. This acoustic effect might be likened to the "stereoscopic" effect encountered in optics.

ducers. The resistances indicated in B as R1 and R2 may have a value of about 100,000 ohms each. As shown, these need not be of the potentiometer type. This circuit has the advantages that one may obtain a variation in quality and volume, in addition to the binaural effect desired. Unit T is the usual output unit.

In circuit A, it is necessary to use the radio set controls for volume, after the two speaker outputs have been balanced against each other. The indicated variation of the output connections employs an output impedance L, and C, the usual fixed condenser.

REFLEXED '22-ACME R.F.T.s AND '22s

(11) Mr. Theodore Dubrule, Ogdensburg, N. Y. (Q.) I have a three-circuit tuner and a center-tapped loop which I would like to use in a reflex circuit. Please print the diagram showing how this may be done, using a screen-grid tube.

(A.) The circuit requested appears in this department.

It will be necessary to rewind the primary L3 of the three-circuit tuner to a total of 25 turns, instead of the ten turns it now has. Coil L1 is the center-tapped loop having about 90 feet of wire wound on a square frame two feet on a side. C1 has a capacity of 0.0005-mf.; C2, the same; C3, .00025 mf.; R is the filament ballast for the '22 tube V1, and R1 for the '01A tube. T is the usual A.F. transformer, of any convenient ratio. L2 has 45

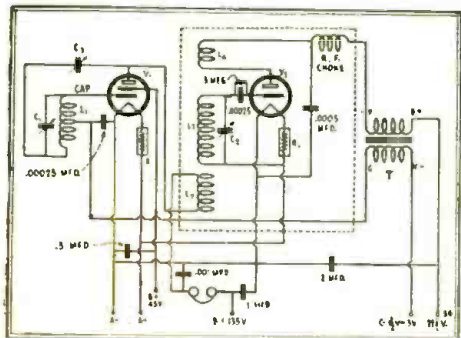

(Q. 11.) An extremely sensitive, regenerative, reflexed loop is circuit pictured, the sensitivity of an average "5-tube radio" set being attained with ease.

turns on a 3-inch tube and L4 is a rotatable tickler of 18 turns.

The screen-grid connects to "G" on the socket and the control-grid to the "cap" lead which runs to one end of L1. A shield for the three-circuit tuner is essential. This shield is shown grounded to "A+"; simply because it is then convenient to arrange the variable condenser mounting without recourse to special insulating

precautions which would be necessary if the case was grounded to "A-," since the variable condenser connects to "A+."

The three-circuit coil should not come closer to the shield than two inches at the two ends; and not closer than one inch at the sides, to prevent broad tuning and loss of volume. Coils L2, L3 and L4 are wound in the same direction.

Although head phones are shown, a single stage of A.F. amplification may be used instead, and is recommended.

Until one has become accustomed to the proper operation of the screen-grid tube, the variable condenser C3 may be left out of the circuit. The usual R.F. choke is used in the detector plate circuit.

(Q.) At present I am using an old-style (loop-pick-up) radio-frequency receiver using Acme R.F. transformers and a potentiometer for control of the amplification. As only a little bit of the potentiometer can be used, before the circuit spills over into violent oscillation, the thought occurred that this was a desirable condition for good operation of screen-grid tubes. Please indicate the changes necessary, if this supposition is correct.

(A.) As the idea is practical, we are showing the circuit requested. Note how easily the changes can be made.

A center-tapped loop is shown, although a two-contact loop may be used, with reduced selectivity. This is not recommended. It would be necessary to connect two half-meg. leaks in series, the center tap going to the A.F. transformer and the two extremes connecting to the two terminals of the loop.

As the Acme transformers R2, R3 and R4 were not designed to realize the maximum amplification of type-'22 tubes, it probably will not be necessary to shield these. If care is taken to run short grid and plate leads, and to place the R.F. transformers at right angles

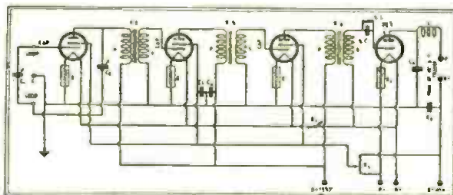

(Q. 11.) A use for the old Acme Reflex Transformers, some of which are in most "experiment stations." Screen grid tubes are featured.

to each other. (Their static and magnetic fields are quite strong.)

Fixed condensers C3, C4, are 0.25-mf., each; C5 is 1-mf., and C6 .0005-mf.

Rheostat R2 is mounted on the baseboard and adjusted until an accurate voltmeter indicates a potential of 3.3 volts at the socket "F" terminals. Resistors R are ten ohms each and R1 is the usual '01A fixed resistor, or a 30-ohm rheostat. The old 1,500-ohm potentiometer is replaced by a potentiometer R3, of 100,000 ohms. GL and GC are the standard grid-leak, grid-condenser combination. If there is circuit oscillation, it may be necessary to by-pass each screen-grid, right at the socket, with a 0.25-mf. fixed condenser. It may be desirable to put a shield over each screen-grid tube.

REGENERATION-CONDENSER LOUD SPEAKER

(12) Mr. Harold Doyle, Enfold, Sask., Canada. (Q.) Can regeneration be added to a 5-tube radio frequency receiver?

(A.) Regeneration can be added to any type of receiver. In the instance above mentioned, the two-circuit radio frequency transformer feeding into the detector may be replaced by a three circuit tuner having a rotatable coil (the tickler), which is to be connected in series in the lead to the audio-frequency transformer from the plate of the detector tube. The primary and secondary of this tuner will have the same values as previously, unless the secondary tunes too high. If so, the remedy for this is to remove a turn or two from the secondary.

(Q.) If a radio set is using a type '71 power tube, how will it be possible to obtain the 500 volts necessary to operate a condenser loud speaker, when these come out, without buying a power plant?

(A.) A circuit in these columns shows an economical way of securing this voltage; bearing in mind that the current drain is only about three or four milliamperes, an audio-frequency transformer with a 2.5-to-1, or even

a 5-to-1 ratio may be used as the voltage step-up unit. If the transformer has a very low primary impedance, it may be desirable to put a 25-watt lamp in series with the 110-volt line. In the event of a breakdown, this lamp will function as a safety device. The tube used at

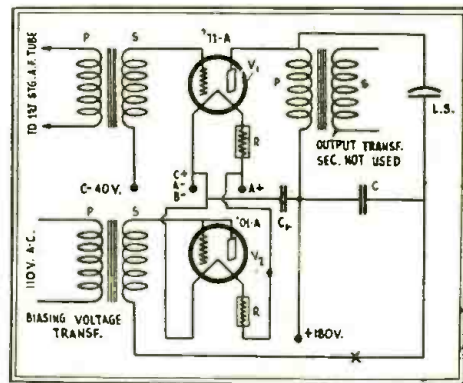

(Q. 12.) The capacitance type reproducer (or condenser loud speaker, as you prefer) source of biasing potential is illustrated.

V2 must be of the latest, high-vacuum '01A type, in order to stand the voltage without arcing or becoming "blue in the face." The grid and plate are connected together, so that they act as one element.

Condensers C and C1 are 1-mf. each. Resistors R are the usual quarter-ampere units.

If additional filtering is required, the capacities of condensers C and C1 may be increased, or an iron core choke coil, condenser bypassed, may be inserted at X.

(Q.) As I would like to make up an experimental circuit to receive long-wave stations for code practice, please print details of this arrangement. If convenient, show how a key may be arranged for code practice.

(A.) We are showing a circuit such as requested. The coils may be purchased (honeycomb type), or they may be made by scramble-winding No. 30 D.C.C. wire on a form two inches in diameter and three-quarters of an inch wide. A three-point tap switch is arranged to select 200, 500 or 750 antenna-circuit turns.

As it is illegal to transmit without a license, a double-pole, double-throw switch has been included. It grounds the aerial and opens the key for use, in one position; and, in the other, it connects the aerial to the set through a fixed condenser (eliminating the need for a third coil—the condenser may be variable, with improved operation) and shorts the key.

The tickler coil should be movably arranged in any convenient manner to control regeneration and R.F. oscillation, and the A.F. oscillation tone.

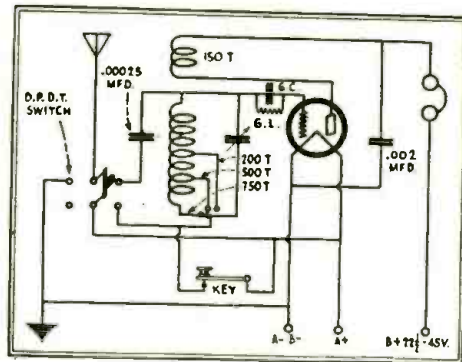

(Q. 12.) Practice in transmission and reception of "dit, dahs" (dots and dashes) is readily obtained with a simple arrangement such as that illustrated above.

As the circuit does not indicate any taps on the tickler coil, there may be a question as to how circuit oscillation can be controlled at extremes of tuning.

If the circuit does not oscillate at all, it is probably due to reversed tickler leads. It would be a good plan to include a variable resistance having a value up to 500,000 ohms in the plate battery supply lead, and apply 45 volts to the resistance, which should be by-passed with a condenser of about one microfarad. This variable resistance will probably be all that is required to give complete control of the circuit performance, even if the constructor should choose to use different coils.

SKINDERVIKEN Transmitter Units

95c

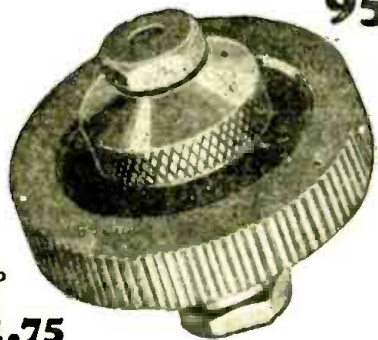

Two for \$1.75

Have hundreds of uses. Every amateur should have two or three of these amplifiers in his laboratory.

A FEW USES FOR THESE UNITS

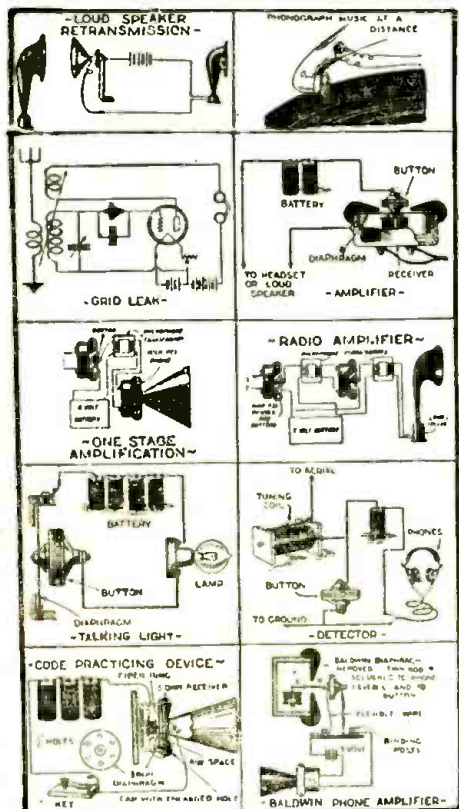

12 PAGE INSTRUCTION BOOKLET containing suggestions and diagrams for innumerable uses, furnished with each unit.

WE PAY \$5.00 IN CASH for every new use developed for this unit and accepted and published by us.

P. G. MICROPHONE TRANSFORMER



A Modulation Transformer specially designed for use with the Skinderviken Transmitter Unit. Has many other uses. Primary resistance. $\frac{1}{2}$ ohm; secondary, .55 ohms.

\$2

FOR SALE AT LEADING DEALERS
Or Order Direct, Using Coupon Below
SEND NO MONEY

When the postman delivers your order you pay him for whatever you have ordered, plus a few cents postage.

PRESS BUILD, INC. R-8-29
16-18-R—East 30th St., New York, N. Y.
Please mail me at once as many of the following items as I have indicated.
... Skinderviken Transmitter Units at 95c. for 1: \$1.75 for 2; \$2.50 for 3; \$3.20 for 4.
... P. G. Microphone Transformers at \$2.
When delivered I will pay the postman the cost of the items specified plus postage.

Name

Address

City

State

Radio for Theatres

(Continued from page 67)

being broadcast over a local station. The switch is thrown connecting the tuner to the amplifier, the tuner filament switch is turned "on" and a turn of the dial knob brings in the desired station.

If the manager of the theatre desires to make an announcement through the group address system, he throws a switch located on the control board of the standard cabinet and talks into the microphone. His voice is then heard, greatly amplified.

From 25 to 30 records, selected from a special "record library," supply the music for a single film. The various records are catalogued and cross-indexed to enable the operator to obtain and use the desired ones, with a minimum of effort. This permits any exhibitor, with no other guide than the producer's *cue sheet*, to select a complete and appropriate musical program to accompany any picture. The records are indexed according to specific needs such as: Dramatic, Hurries, Joyfulness, Love Theme, Mysterious, Marches, National, Oriental, Popular, Quietude, Religious, Sad, Wedding, Western, Scenic as well as a large collection of *special sound effects*.

List of Parts for the Radio Tuner

- 1—Aero Universal Tuned Radio Frequency Kit, type U-12, consisting of 3 matched R.F. Transformers, 4, 10, 18
- 1—Additional Aero Universal R.F. Transformer, same type as in U-12 Kit, 26
- 2—.0005 Mfd. Two-Gang Hammarlund Multiple "Mid-Line" Condensers, "Battleship" model, type BSD-50, 5, 12, 20, 28
- 1—Electrad Tonatrol, type "A", 2
- 3—1000-ohm Electrad Truvolt flexible Wire-wound Resistances, 11, 19, 27
- 3—500-ohm Electrad Truvolt flexible Wire Grid Resistances, 6, 13, 21
- 7— $\frac{1}{2}$ Mfd. Polymet "Hi Volt" Filter Condensers, type C-903, 8, 8a, 14, 14a, 22, 22a, 29
- 1—1 Mfd. Polymet "Hi Volt" Filter Condenser type C-904, 36
- 1—.001 Mfd. Polymet Fixed Mica Condenser, 32
- 1—Thordarson Filament Transformer, T-2504, 42
- 1—Carter "Imp" Power Switch, 43
- 1—Carter 20-ohm Potentiometer, type MP20, 41
- 4—Gold Seal Tubes, type GSY 227, 7, 16, 24, 30
- 4—Eby Sockets, UY type, 7, 16, 24, 30

Agents Wanted

FREE BOOK. Start little Mail Order business. Hadw. 1. 27A-74 Cortlandt Street, N. Y.

Reproduce Signs, Pictures, Typewriting without type or press. Simple, inexpensive. Samples and particulars 10c. Straley, 13 $\frac{1}{4}$ W. Main, Springfield, Ohio.

Instruction

Be the Licensed Radio Doctor of your community. Earn \$7.00-\$10.00 spare time evenings. Write now for free booklet, "Why the Radio Doctor." Dept. C, 131 Essex Street, Salem, Massachusetts.

Motion Pictures

Good standard movie films, 300 feet \$1.00. Samples, Particulars Free. Eastin Feature Films—Dept. B—Galesburg, Ill.

Opportunity

501 Ways to make money. Particulars free. C. Terry, 1964 West 7th Street, Brooklyn, N. Y.

- 7—Eby Engraved Binding Posts, 1, 3, 24, 35, 69a, 70a, 71a
- 3—2000-ohm Durham Metallized Resistor "Powerohms" with Durham Vertical Single Mountings, 9, 15, 23
- 1—8000-ohm Durham Metallized Resistor "Powerohm" with Durham Vertical Single Mounting, 31
- 4—Amperites, No. 227, with Mountings, 37, 38, 39, 40.
- 1—Silver-Marshall Drum Dial, type 810, with escutcheon plate
- 4—Silver-Marshall Shields, type 631-A
- 1—Silver-Marshall R.F. Choke, type 276, 33
- 1—Can Kester Radio Solder (Rosin Core)
- 1—Roll Corwico Braidite, *Stranded Core* Hook-up Wire
- 2—Small Adjustable Condensers (Muter or X-L) .00002 Mfd. to .0001 Mfd., 17, 25.
- 1—Composition Panel, 7" x 21" x $\frac{3}{16}$ "
- 1—3-Ply Wood Baseboard, 12" x 20" x $\frac{1}{2}$ "

List of Parts for "B" Supply and Audio Amplifier

- 1—Thordarson R-245 Power Compact, 66
- 1—Polymet Block Condenser, type F-1000, 63, 8 Mfds.; 64, 2 Mfds.; 65, 2 Mfds.; 47, 1 Mfd.; 51, 1 Mfd.
- 1—1 Mfd. Polymet "Hi-Volt" Filter Condenser, type C-904, 54
- 1—Electrad Truvolt Tapped Unit Resistor, type C 130 S, 62
- 1—Electrad Truvolt Variable Power Resistor, type T-10, 56
- 1—2000-ohm Electrad Truvolt Wire-Wound Resistor, 50
- 2—50,000-ohm Durham Metallized Resistor "Powerohms" with Durham Single Vertical Mountings, 48, 55
- 7—Eby Engraved Binding Posts, 44, 45, 67, 68, 69, 70, 71
- 1—10,000-ohm Carter Resistor, type P-10, 53
- 1—Carter center-tapped 30-ohm resistor, 57A.
- 1—Amperite No. 227, with mounting, 49A.
- 2—Carter "Imp" Jacks, 60, 61
- 1—Thordarson R-300 Audio Transformer, 46
- 1—Thordarson Push-Pull Input Transformer, type T-2922, 52
- 1—Thordarson Output Transformer, type T-2902, 59
- 1—Eby Socket, UY type, 49
- 3—Eby Sockets, UX type, 57, 58, 72
- 1—Gold Seal Full Wave Rectifier Tube, type GSX 280, 72
- 1—Gold Seal Tube, type GSY 227, 49
- 2—Gold Seal Power Tubes, GSX 245, 57, 58
- 1—Roll Corwico Braidite, *Solid Core* Hookup Wire
- 1—Wood Base

List of Parts For Group Address System

- 1—Amplion Cabinet, type PMS-2 Standard, containing 2 turntables, electric motors, Amplion magnetic Pickups and control board
- 1—Amplion Desk Stand Microphone
- 1—Microphone Amplifier
- 1—Amplion Giant Dynamic Air Column Unit, type AC-100
- 1—Amplion Exponential 10-ft. Air Col. Horn, type A-10
- 1—Exciter for Amplion Giant Dynamic Unit

Note: Numbers in bold face type refer to corresponding numbers marking parts on diagrams.

SEMI-ANNUAL INVENTORY CLEARANCE SALE SILVER - MARSHALL KITS - SETS - PARTS

The thousands of service stations and established custom set builders that have wisely used Silver-Marshall equipment exclusively, will be first to purchase this apparatus advertised, in quantities sufficient to last them until the Fall season. To others, this is your money making opportunity to become acquainted with the superior merits of the world renowned SILVER-MARSHALL line. **OUR DISCOUNT IS AT LEAST 40% LESS THAN ANY OTHER ADVERTISED NET PRICES!**

All merchandise is brand new and is fully guaranteed by SILVER-MARSHALL CO. and ourselves.

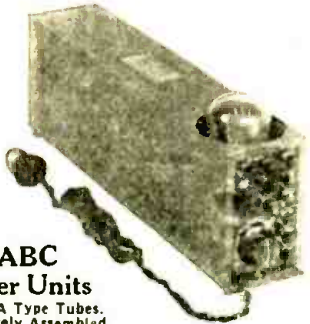

S-M 670 ABC Power Units
For 171A Type Tubes.
Completely Assembled.

The set-builder will find these eliminators to be an unailing source of power for A.C. or D.C. tube receivers. Uses a 280 type rectifier. Furnish fixed B voltages of 22,90, 135,180, and variable 22-90 at a total of 60 m.a. In addition to this the 670 ABC can supply C voltage, and 1 1/2 volts at 4 amperes, 2 1/2 volts at 3 1/2 amperes and 5 volts at 1 ampere for A.C. tube equipped receivers. Operate direct from any 105-120 volt 50 to 60 cycle A.C., and are housed in brown crystalline-finish cases, 17" by 3-5/16" by 5 3/4".
List Price \$48.00;
Your Net Cost..... **\$14.90**

The New S-M 720AC Screen-Grid Six (All-Electric)

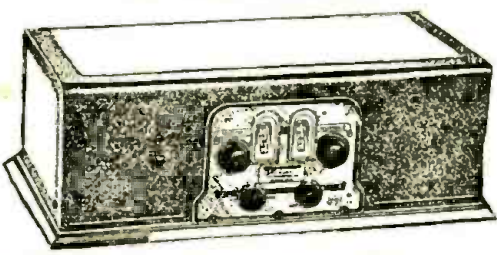

Specially designed for obtaining the maximum efficiency from three shielded r.f. stages utilizing these new A.C. screen-grid tubes (amplification constant of 420 per tube) plus a power detector, and two stages of Clough system audio amplification; the last stage of audio uses UX245 tube, which has an undistorted power output of 1800 milliwatts—ample for the largest home. And the tone quality—so pure, so realistic, and so lifelike, that those hearing the 720AC for the first time, are held fast in amazement!

Tubes Required: Three UY-224—Two UY-227—One UX-245.
List Price \$78.50;
Your Net Cost..... **\$28.24**

720 DC Screen Grid Model
Tubes required: Three UX222—One 201A—One 112A and one of any of the last stage power tubes.
List Price \$72.50;
Your Net Cost..... **\$26.87**

S-M 675 ABC Power Supply



For 210 and 250 Type Tubes.
Completely Assembled

Provides a super-power stage of amplification for any radio receiver without changing set wiring. An adapter is merely inserted in the last tube socket and a 210 or 250 type tube plugged into this adapter. Uses one UX281 tube, and furnishes 425, 135, 90, 22, and variable 22-90 B voltages for any receiver. In addition to this, C voltage and A power at 1.5 volts, 4 amperes 2.25 volts, 4 amperes and 7.5 volts (for 210 or 250 tube).
List Price \$58.00;
Your Net Cost..... **\$24.95**

New S-M 669 ABC Power Supply for 224 and 245 Type Tubes
Using one UX280 tube. Furnishes fixed B voltages of about 67, 180, and 300 volts at a maximum current drain of 100 m.a. In addition, 2.25 volts, 6 amperes, and 2.25 ampere, C voltages and A power at 1.5 volts, 4 volts at 9 amperes is furnished for 224, 227 and 245 type tubes. Provides field wiring for a 90-120 volt D.C. dynamic speaker!
List Price \$57.50;
Your Net Cost..... **\$22.50**



S-M 730 Round-the-World Four

Have you had your taste of the "thrill band"—the wavelength band from 17 to 200 meters? Down on these low waves are the foreign broadcasters—English 5SW with Colonial programs, Dutch, French, Russian, German and other rebroadcast programs, also

TELEVISION BROADCASTS!
These receivers use one screen-grid tube in a single stage of radio frequency amplification, followed by a non-radiating regenerative detector. The regeneration control is smooth over the entire band. There is but one tuning dial, with variable vernier reduction so that the tuning is not critical. A similar vernier dial controls the regeneration condenser.

The range for loud speaker reception is practically unlimited. It being regular practice to listen to five continents in an evening on the set.

A complete short wave receiver and two-stage audio amplifier. Covers the whole range between 17.4 and 204 meters, efficiently and smoothly. All wavelengths are covered with no dead spots. Built into a very attractive aluminum shielding cabinet. The coils plug into a socket mounted on top of the cabinet for easy and rapid wave-length change.

The tubes required are: 1—UX222 screen grid amplifier, 2—UX201A or UX112A detector and amplifier tubes, and 1—UX112A or UX171A power tube.
List Price \$51.00;
Your Net Cost..... **\$21.50**

KIT
Completely Wired Ready for Immediate Use..... **\$26.50**

Radax 171 Compact Eliminator Kit—220 Volt Output

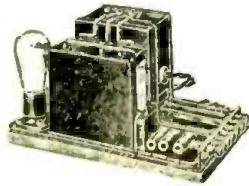

It can be assembled by the most inexperienced in less than 30 minutes. Only the highest quality parts used—such as Thordarson-Radax Compact (power transformer and two chokes). Approximate size, 9"x11". Requires one Raytheon Tube (\$2.65 extra)
List Price, \$33.80;
Your Net Cost..... **\$8.90**



Silver-Marshall Sargent Rayment 710 7 TUBES. COMPLETELY ASSEMBLED.
Four Screen Grid Tubes Used.
Station after station, near and far, DX and local, literally plug in and out with the positive, clear-cut selectivity that lets you get a station for every ten-kilocycle channel—95 to 100 stations in an evening under favorable conditions. An interesting feat of a 710 Sargent-Rayment Seven Receiver is the authentic reception in New York City of Station 2BL, Sidney, New South Wales, Australia. Thick aluminum shielding and chassis finished in satin silver. Consists of five sharply tuned circuits in a four-stage screen grid R.F. amplifier, all tuned by a single illuminated drum, and each stage provided with individual verniers. Tubes required are two 112A, four 222, and one 171A, or one 250 Super Power Tube.
YOUR SPECIAL NET COST..... **\$67.80**
List \$175.00

KIT **\$58.00**

AC KIT
YOUR NET COST **\$65.00**

AC WIRED
YOUR NET COST **\$72.00**

Karlson-Thordarson 210 Phonograph Amplifier Kit



A complete compact, self contained 2 stage amplifier designed for use with a phonograph pickup and any good speaker.
Tubes required: one 227, one 210, one 281.
List Price \$61.25;
Your Net Cost..... **\$17.90**

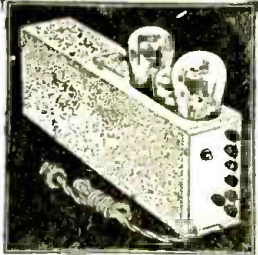

S-M 678PD Phonograph or Radio Two Stage Amplifier
Completely Assembled

Here is a two-stage socket-powered audio amplifier using one '26, one '50, and one '81 tube, and taking all power from any 105 to 120 volt, 50 to 60 cycle, A.C. lamp socket. It may be used to operate a dynamic loud speaker from a radio detector tube, or from a magnetic phonograph record pickup. Will supply field current to any dynamic speaker having a 110 volt D.C. field coil; or it will operate two dynamic speakers. One UX281 rectifier tube is used, one UX228 first stage amplifier and one UX250 (CX350) power tube.
List Price \$73.00;
Your Net Cost..... **\$28.80**

60% Discount
S-M 850 A. C. DYNAMIC SPEAKER

List \$58.50. Net **\$23.40**
Uses 280 Tube for Rectifier

WHOLESALE PRICES

JUST OFF THE PRESS!

2ND EDITION

**FREE
FREE
FREE
FREE**



for Dealers, Community Set Builders, General Repairmen and Agents!

Our new, **HUGE, LARGER PAGE SIZE** (8" x 10½") **WHOLESALE CATALOG No. 19, 2nd Edition**, enjoys the enviable distinction of being universally accepted by the **RADIO TRADE** in the same manner that a school treasures the **Dictionary and Encyclopedia Britannica**—or the home the **Bible and Almanac!!**

The preparation and distribution of this **MAMMOTH Catalog COSTS A TREMENDOUS SUM**—the huge volume of business derived from it warrants this cost as well as the genuine pleasure it gives us to know that those "in the know" regard our catalog **AS THE OFFICIAL ORGAN OF THE 1929 RADIO SEASON!!!**

This **FREE CATALOG** is literally a most valuable **ENCYCLOPEDIA**—**YOU** cannot well afford to be without one—and, you do not have to. Your request for one is all that is needed! A day or two later, it is in your possession! Surely, a **TEST OF OUR PROMPTNESS PLEDGE!**

OUR CATALOG LISTS MORE Completely Assembled All-Electric A.C. Receivers

than any other Radio Catalog!
AVAILABLE IN CHASSIS FORM, OR MOUNTED IN TABLE OR CONSOLE CABINETS, WITH AND WITHOUT BUILT-IN LOUD SPEAKERS.
Our Rock-Bottom Net Prices for these sets will astound you!

Those having No. 18, or No. 19 (1st Edition) Catalog, should immediately send for No. 19, 2ND EDITION. ALL PRICES HAVE BEEN REDUCED TREMENDOUSLY!

Buy from Radio's Oldest Mail Order House!

In these many years we have been in the Radio Mail Order Business, we have learned from **EXPERIENCE** how such an organization must be efficiently run in order to **GAIN AND RETAIN THE GOOD WILL OF OUR CUSTOMERS**. In this, our **DETERMINED GOAL**, **RADIO SPECIALTY COMPANY OFFERS TO SHIP PRACTICALLY ALL ORDERS IN FROM 6 to 24 HOURS**—OFFERS YOU **100% QUALITY MERCHANDISE ON A STRICT MONEY-BACK BASIS IF NOT THOROUGHLY SATISFIED**—AND OFFERS YOU ALL MERCHANDISE AT **ABSOLUTE ROCK BOTTOM NET PRICES!**

OUR CATALOGUE CONTAINS THE **LARGEST ASSORTMENT OF GENERAL RADIO MERCHANDISE IN THE COUNTRY**. Only the most successful manufacturers' products are listed—such lines as **PILOT—SILVER-MARSHALL—CARTER—AERO—YAXLEY—TOBE—HAMMARLUND—AMER-TRAN—CUNNINGHAM—DONGAN—THORDARSON—MUTER**, etc. etc. THE **LATEST IMPROVEMENTS IN RADIO ARE LISTED AND THOROUGHLY DESCRIBED IN THIS GREAT CATALOG**: **A.C. ALL ELECTRIC Sets** with self-contained **ABC power supply**—**Public Address Amplifier systems**—**A.C. Set Converters**—**A and B Eliminators**—**Dynamic Speakers and Units**—**Magnetic Speaker Chasses**—**245 and 250 Tube Amplifiers**—**Airplane Cloth Speakers**—**Push-Pull Power Amplifiers**—**Electric Phonograph Turn-Tables**—**Combination Radio and Electric Phonograph Consoles**—**Speaker Tables**—**Short Wave**

Sets and Adapters—Shield Grid Tube E'ta—Television Parts. Cameras—Workshops—and large assortment of Lathes, Electric Drills, Electric Saws, Electric Grinders, etc.—Violet Ray Machines, Electric Flatirons, Stoves, Percolators, Toasters, Fans, Washing Machines. LOGICALLY HOW CAN YOU AFFORD TO BE WITHOUT OUR CATALOG—SEND FOR ONE NOW!

And, if we do not list in our catalog your Radio requirements, **WE WILL OBTAIN SUCH PARTS, BILLING YOU AT THE USUAL TRADE DISCOUNTS!**

"RASCOS" has it
Radio Specialty Co.

98C PARK PLACE, NEW YORK



Short-Wave Notes

(Continued from page 71)

If you are using an '00A, or an '01A, do not go above 45 volts, as they are difficult to control with higher "B" voltages. A voltage of 45 is about right. Perform the same operation with all

perimenting with short wave sets, having been particularly concerned with the development of an advanced receiver recently placed on the market, and always prefers the series feed. It is more reliable than the shunt feed scheme, because it is not dependent on the R.F. choke. With the series feed, the radio-frequency

Standard 3-circuit regenerative receiver for short wave reception, incorporating variable antenna coupling, variable detector "B," and smoother regeneration. The rotor of the regeneration condenser connects to the "A" circuit, to prevent hand capacity effect. For code reception, a cheap, high ratio A.F. transformer is best.

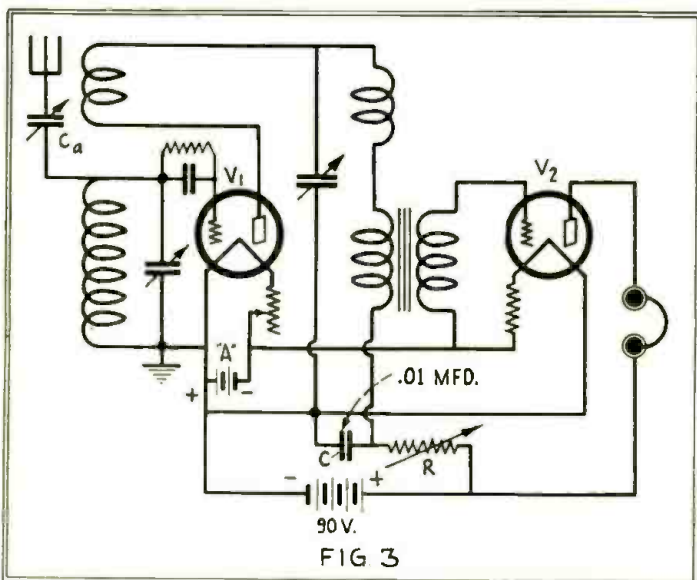

the other plug-in coils; of course if you have a set using a stage of tuned R.F. ahead of the detector you don't have to touch the antenna coils, as these do not carry tickler windings.

Best Tickler Hookup

Incidentally, there is some question among short wave experimenters as to what is the best connection for the tickler. There are two possible arrangements, shown schematically in Figs. 1 and 2.

Fig. 1 shows the "series feed," with the tickler connected in series with the plate circuit of the detector and with the regeneration condenser C between the top end of the tickler and the filament. A radio-frequency choke, R.F., is usually included, but it is not always necessary, as many people have discovered.

component of the plate current *must* go through the tickler, because it has no other path; therefore, the R.F. choke is more or less superfluous, although helpful if the first audio transformer has a primary winding of high self-capacity. With the shunt-feed, the R.F. component of the plate current is forced through the tickler only because it is kept out of the audio transformer by the R.F. choke. If the choke happens to have electrical "holes" in it, as many have, the R.F. is short-circuited by the self-capacity of the transformer primary, and hence there is no feed-back and no regeneration at those points.

It is extremely difficult—practically impossible, in fact—to build a single R.F. choke that has an effective blocking action on the wide band of wavelengths the average amateur short-wave set per-

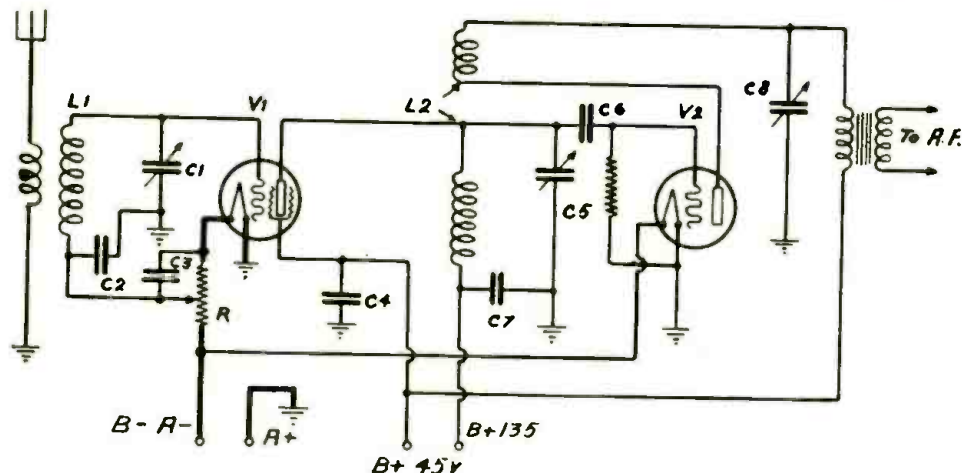

Fig. 6. Schematic circuit of a receiver embodying the ideas described in the accompanying article. This shows how a screen grid tube can be added to a typical regenerative circuit, such as Fig. 3.

Fig. 2 shows the "shunt feed" system, so called because the tickler and its control condenser C are bridged across the plate circuit of the tube.

The writer has done considerable ex-

periments over. Those few experimenters who prefer the shunt feed hookup find it necessary to change chokes as they change tuning coils—a troublesome and altogether unnecessary procedure. The

FIRST

Again!

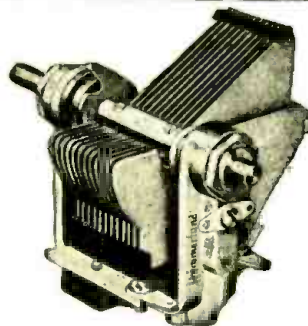

In the
MOORE-DANIELS
Receiver—

you will find specified 10 Hammarlund Precision Products, from Condensers and Drum Dials to Flexible Couplings.

This is just another of hundreds of instances where designers of featured circuits insure results, by specifying Hammarlund Products of proved reliability.

Write Dept. RC-8 for Folders

HAMMARLUND MFG. CO.
424-438 West 33rd Street, New York

For Better Radio
Hammarlund
PRECISION
PRODUCTS

Radio Fans !!

ELECTEX

"The Battery Food"

Saves money by extending battery performance, prevents excessive sulphation, buckling and warping of plates. ELECTEX will prove dependable, serviceable and efficient. ELECTEX applied to your battery will make every charge last longer. ELECTEX is sold on a MONEY-BACK guarantee.



PRICE
\$2.00
at all
dealers*
or write
direct to

GOODYEAR CHEMICAL CO., Inc.
20R West 22nd Street,
New York, N. Y.
*Dealers write for proposition.

When writing to advertisers, please mention RADIO-CRAFT.

Most Astounding Value Ever Offered!

KOLSTER

ELECTRO-DYNAMIC REPRODUCER

Combined with 210 Power Amplifier and "B" Supply Unit

THESE Dynamic Reproducers are Kolster built, packed in the original cases and cartons, shipped direct to us from the Kolster factory from whom we have purchased all of these Dynamic Reproducers. Every Dynamic Reproducer is brand new, each bears the Kolster guarantee tag and the original serial number.

Such opportunity as herein presented is seldom available. And they won't last long at this low price. We suggest quick action—there's quality here—at a price heretofore unknown.

THIS finely matched, rugged unit comprises a complete heavy duty Electro-Dynamic Reproducer, including a 210 Power Amplifier with "B" supply unit, all self-contained on a steel frame. It weighs 45 pounds without the cabinet. The cabinet itself is of pencil-striped walnut, beautifully designed with Cathedral grille. It is equipped with switch for control of house current to reproducer, power unit and amplifier. A pilot light indicates when the Reproducer is in operation.

If desired, the 210 Power Amplifier will also supply 22, 67 and 90 volts "B" current, sufficient for any set using up to 8 tubes. An automatic voltage regulator tube, UX-874, maintains the "B" voltage silent and steady.

This Electro-Dynamic Reproducer can be used with any battery or A.C. set, replacing the last audio stage or be used with all tubes of the set. Wherever used, it will bring out every shading and range of tone; every note is reproduced with utmost faithfulness, pure and undistorted. It will modernize any radio receiver.

The following tubes are required for its operation: 2-UX-281 (for full-wave rectification); 1-UX-210 (for super power amplification); 1-UX-874 (for voltage regulation). For use with phonograph pick-up, one additional audio stage is recommended between the pick-up and this Reproducer.

A 20-ft. cable is included with each instrument. Operates direct from 50-60 cycle, 110-120 volt A.C. current.

Licensed under patents of RCA and Lektophone Corp.



MODEL K-5

Height 42"
Width 25 1/2"
Depth 19"

Features:

1. Electro - Dynamic Reproducer (10 1/4-in. dia.)
2. 210 Power Amplifier. Fine tone quality.
3. Supplies "B" voltage, if desired.
4. Can be used with any electric or battery set.
5. Complete A.C. Electric operation.
6. Beautiful pencil - striped walnut cabinet.

List Price \$175.00 *Never* **\$49.50**
(without tubes) *Before*

Terms: 25% cash with order, balance C.O.D., F.O.B., New York

American Sales Co., 19-21 Warren St., New York City

Newest Aero Hook-Ups and Short Wave Guide — Free!

Send now for the newest radio hook-up book. Shows how easy it is to build remarkable new A.C. and D.C. receivers of longest range, greatest volume, purest, clearest tone, and super-selective. Also shows how to make short-wave receivers and adapters, how to use new screen grid tube in A.C. and D.C. circuits, how to take advantage of short-wave for long distance. Latest information on all new radio wrinkles. Send for free copy now.

AERO PRODUCTS, Inc., Dept. 2589

4611 E. Ravenswood Ave., Chicago, U. S. A.

Name.....
St. and No.....
City and State.....



New Kind Of Can Opener

WORKS LIKE MAGIC

At last! An Automatic, simple little can opening machine for the home! This revolutionary invention in only a few short months has banished old can openers from over 100,000 kitchens. And no wonder! Imagine an amazing, lifetime device that holds the can and cuts out the top leavok can rim slick, smooth and clean. Just turn a crank, that's all. Approved by Good Housekeeping Inst., Modern Pricella, etc. Write today for special introductory advertising offer.

AGENTS

Men and Women make \$6 to \$12 an hour, full or spare time. Big, worthwhile commissions on every sale. Exclusive Territories. Send quick for FREE OUT FIT and FREE TEST Offers.

CENTRAL STATES MFG. CO.
Dept. K-2572
4500 Mary Ave. St. Louis, Mo.

series feed is obviously the better arrangement.

Correct Grid Leak

The effects of the grid leak value and the "B" voltage applied to the detector have often been emphasized. It is easy enough to try different grid leaks, but not so very easy to change the battery voltage. Most "B" batteries have taps only for 22 1/2 and 45 volts, and sometimes it is very evident from the operation of a set that some intermediate value would be very desirable. For instance, the coils may not oscillate from

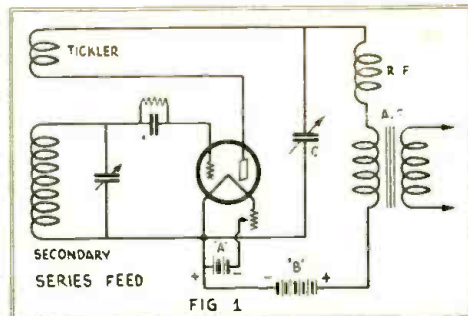

The recommended method for controlling regeneration, smoothly and without "dead spots."

0 to 100 on the tuning condenser with only 22 1/2 volts, but they "plop" with an uncontrollable bang on 45. If a number of different tubes all behave the same way, with different grid leaks, the only thing to do is to insert a variable resistor in the "B" lead to the detector tube. See Fig. 3, where R is the resistor and C a by-pass condenser of .01 mf. capacity. More will be said about by-pass condensers later.

The resistor should be of the so-called "universal range" type, with a resistance variation from about 40 ohms to 10,000,000. If there is already a separate "B" detector plate lead, insert the variable resistance in series with the wire, bringing the by-pass condenser from the "B" side of the transformer primary to the filament. If you are now building a short-wave receiver, you can save one battery lead and one binding post by simply connecting the resistor R to the same 90-volt tap feeding the audio tube or tubes. The resistor can be placed on the sub-panel; like the aerial coupling condenser Ca, it is left alone after being adjusted. Its best setting is quickly found with a little experimenting.

Correct By-Pass

The matter of by-pass condensers deserves a little attention. In the past, most instructions for by-passing have called for condensers of 1/2 and 1.0 mf. capacity, and these sizes have become more or less arbitrary standards. For short wave sets, where the frequencies run into the millions, these condensers are much, much bigger than necessary. They occupy a lot of room, and the work they do can be done fully as well by condensers of considerably lower capacity. The .01-mf. size is very convenient, because the condenser itself is comparatively small, being of the same dimensions as the usual grid condenser. Its reactance to the high frequencies that roam around in short wave circuits is an infinitesimal

When writing to advertisers, please mention RADIO-CRAFT.

fraction of an ohm, so it is perfectly satisfactory from every standpoint.

With the advent of screen-grid short wave receivers assembled on all-metal chasses, we must learn that one side of each tube filament is invariably "grounded" directly to the framework. If we want to bias the grid of the screen-grid tube by using the conveniently available voltage drop across a tapped filament resistor, as in Fig. 4, we find that serious trouble rises. One side of the tuning condenser C1 is also grounded, and since the bottom end of the tuning inductor L must be connected to the same point, we have a short circuit if we bring the end of L also to the tap on the resistor, where it rightfully belongs. Trace out the circuit yourself: "A—" to resistor R, through ground on L and C and back to grounded "A+." Lovely, isn't it? (Result—burnout of resistor, R.—Ed.).

The Tuning Condensers

The trick merely is to insert a condenser between the bottom of L and the grounded side of C1, so that while the radio-frequency current of the tuning circuit will have a complete path in which to circulate, the direct current obtained from the tapped resistor R will not get back to the ground. This biasing voltage now has no place to go but to the grid, where we wanted it in the first place. (See Fig. 5.)

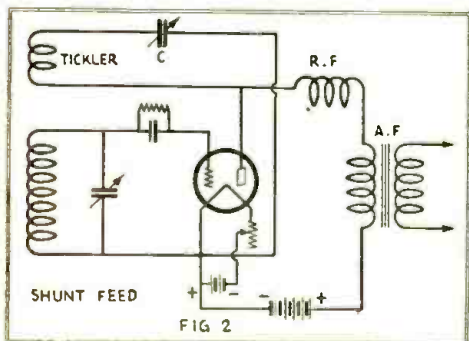

Until recently, this was the recommended connection for regeneration control.

Condenser C2 can be anything of large size, .01-mf. being a convenient and satisfactory capacity. It is in series with the L-C1 tuning circuit, but it is so large that it has no appreciable tuning effect.

A similar use for a condenser to block direct current but to pass R.F. current is illustrated in Fig. 6, which is a diagram of a typical tuned screen-grid short wave set. The R.F. portion is like that of Fig. 5, with an additional .01-mf. bypass C3, across the filament resistor for the screen grid tube V1. The latter is direct coupled to the detector, V2. The problem is to feed 135 volts of "B" battery to the plate of V1 without starting any fires in the detector circuit.

The blocking condenser C7, again of .01-mf., does the trick with the aid of the grid condenser C6. The "B+135" is led right through the grid coil of the detector plug-in coil L2, but is insulated from the grid of V2 by condenser C6, and is prevented from short circuiting back to ground by the condenser C7. The latter completes the R.F. tuning circuit of L2 and C5, just as C2 performs an identical service for L1 and C1.

It's Here! the Tuned Underground Aerial for Better Reception

Here's great news! For the same cost as an ordinary overhead aerial you can now enjoy greatly improved reception and be through once and for all with the old-fashioned, inconvenient, noise-gathering roof aerial. There has been such a great demand for an improved underground aerial that for over a year we have kept engineers busy designing, testing and perfecting a satisfactory device. The result is the new amazing SUB-TONE. It is designed to decrease static and noise, get finer selectivity and give true radio enjoyment, by virtue of Tuning the underground aerial to the radio circuit.

With an untuned aerial, frequently the sensitivity of the set is not great enough to give the broadcast signal a predominant strength over the existing noise level. As a result, static predominates and the set is unable to get the desired broadcasts.

With Sub-Tone, the aerial is tuned to the broadcast being received. This allows the broadcast signal to have greater strength than the static and noise. Finer selectivity is allowed and reception is clearer and more enjoyable.

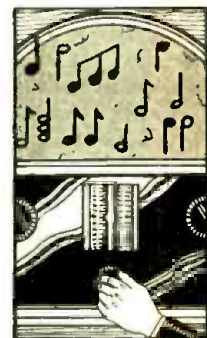

It's So Simple a Child Could Install It!



Takes but a few minutes. Just dig a small hole and place the aerial in it. Sub-Tone is also equipped with a scientific ground plate, so that you can take care of antenna and ground in one simple operation. The lead-in wires are brought to the set—the aerial wire connecting first to a binding post on the Tuner, a small, compact device that can be placed in the radio cabinet or any convenient place near it. Your aerial is out of sight and protected from lightning, soot, wind and interference. You avoid many aerial troubles with the use of Sub-Tone.

Try SUB-TONE On Your Own Set FREE!

You don't need to take our word for the merits of Sub-Tone—we want you to try it and prove to yourself what tests and reports from users have already proved to us. Put in a Sub-Tone entirely at our risk. Just hear the difference and judge for yourself! If you aren't delighted with the improvement, the trial doesn't cost you a cent. Send for all the startling information on Sub-Tone. You've a surprise waiting for you. Write today!

BETTER RADIO PRODUCTS

141 W. Austin Ave., Dept. 831-L.T., Chicago, Ill.

BETTER RADIO PRODUCTS, 141 W. Austin Ave., Dept. 831-L.T., Chicago, Ill.

Rush details and proof on Sub-Tone, the new Tuned Underground Aerial, and how I can test it Free.

Name
 Address
 City State



PATENTS TRADE-MARKS

Don't Lose Your Rights To Patent Protection

Before disclosing your invention to anyone send for blank form "EVIDENCE OF CONCEPTION" to be signed and witnessed.

LANCASTER & ALLWINE
475 Ouray Bldg., Washington, D. C.
Originators of forms "Evidence of Conception"

Buy from RADIO-CRAFT advertisers, they are reliable and well-known.

ELECTRIFY YOUR RADIO FOR ONLY \$6.85 COMPLETE

Why discard your present good set when you can electrify it for only \$6.85, and banish the annoyance and expense of buying new "B" batteries?



OVER 100,000 TOWNSEND "B" POWER UNITS IN USE
 Hooked up in a few minutes. Use same tubes—no changes. You'll be amazed at the improvement in reception and distance getting. Send name and address today for full details. Proof and Free Trial Offer.

TOWNSEND LABORATORIES,
 723 Townsend St., Chicago, Ill.
 Please send me full information on the Townsend "B" Power and Free Trial Offer.

Name
 Address
 City State



NEW TYPE B. T.

ARMORED CONDENSER

The United Scientific Laboratories have produced this new Armored type B. T. Condenser, to meet the growing demand for precision combined with rigidity. No set builder whose specifications and requirements demand ultra precision, electrical and mechanical perfection, and compactness, can overlook this high grade instrument.

Note These Exclusive Features

- 1—Rigid frame made of heavy drawn steel.
- 2—Rotors and stators are precision spaced and soldered.
- 3—Accuracy and calibration in ganging is assured by wide spacing between plates.
- 4—Permanent and perfect alignment of rotors is assured because the removable shaft is independent of bearings.
- 5—Circuit adjustments are facilitated by the gradual curve on the minimum capacity adjuster.
- 6—Adjustable smooth acting end thrust and tension fork.
- 7—The compactness of this condenser makes it the most convenient tuning unit made for individual shielding work.

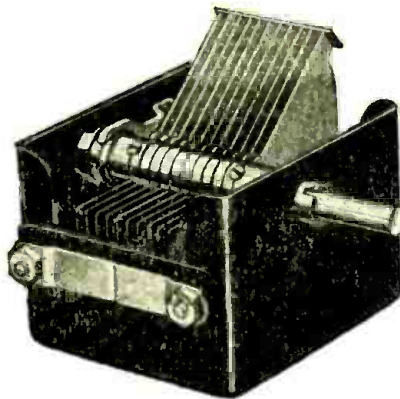

Made in single, two gang, three gang, and four gang units of .00035 mfd. capacity and lower. Samples now ready for delivery. Write for prices and full information.

United Scientific Lab., Inc., 113 Fourth Ave., New York

FREE SERVICE DEPARTMENT

Questions on "where to buy" and "what to buy" are answered by our Service Department. So really it doesn't matter what the question is, you're bound to get the information you want.

National Radio Trade Directory answers over 5,000 perplexing questions a year.

If You Want To Know The Address Of Any MANUFACTURER, JOBBER, AGENT OR REPRESENTATIVE LOCAL SALES OFFICE, TRADE-MARK OWNERSHIP, PHOTOGRAPH OF PROMINENT INDIVIDUALS CONNECTED WITH THE RADIO TRADE OR THE ADVERTISING AGENCY OF ANY MANUFACTURER OR JOBBER OR ANY OTHER

RADIO INFORMATION
WHERE TO BUY OR SELL
WRITE, PHONE OR WIRE US

NATIONAL RADIO TRADE DIRECTORY
Addressing & Mailing  *Printing & Multigraphing*

303 FOURTH AVENUE

NEW YORK CITY

Gramercy 5433

BOOK REVIEW

Treatise on Testing Units for Service Men.

By John F. Rider, published by Radio Treatise Co., 1440 Broadway, N. Y. C.; 6" x 9", 43 text pages, 44 illustrations, 2 tables, paper cover. Price, \$1.00.

This is one of those times when we may quote, "Little, but Oh, My!" Every necessary photograph and diagram has been included. The type is very small and has been set "solid." Much valuable information has been crowded in a small space.

We are pleased to find an unusual convenience. In addition to the text pages, there are an equal number of blank pages; every text page facing a blank page which may be used for annotations.

Whether one wishes to have a copy of this inexpensive treatise may be determined by perusal of the Table of Contents:

Section 1: Tube Reactivator; Reactivating voltages, electronic-emission table; Calibrated vacuum-tube bridge; General-utility tube tester; Weston AC-DC receiver tester, model 537

Section 2: "B" eliminator tester; A signal generator for receiver testing.

Section 3: Self-modulated oscillator; Beat-note audio oscillator; Cathode-ray oscillograph tube.

Section 4: Output indicating systems; Tube voltmeter; Measurement of inductance and impedance; Measurement of capacity; A resonance indicator; D.C. resistance measurement.

Section 5: Multi-range meters; Voltmeter multipliers; Improvised high-resistance voltmeter; Current meters and shunts; Service station test bench, panel and units.

Appendix: D.C. permanent magnet, pivoted-coil meter; Movable-iron electromagnetic instruments.

A *Treatise on Testing Units for Service Men* is an excellent reference book for anyone interested in the subjects referred to in the above contents table

Radio Telegraphy and Telephony.

By Rudolph L. Duncan and Charles E. Drew, published by John Wiley and Sons, Inc., N. Y. C. (Chapman and Hall, Ltd., London); 6" x 9", 950 pages, 500 illustrations (approx.), cloth cover. Price, \$7.50.

The authors (Rudolph L. Duncan, Director, Radio Institute of America—a division of the RCA; Captain, S. C. R., U. S. Army; Member, I.R.E.; Member, Radio Club of America; Member, Veteran Wireless Operators Association; and Charles E. Drew, Instructor in Radio, and in charge of Electrical Division, Radio Institute of America; Member, Radio Club of America; formerly Instructor, U. S. Naval Wireless Telephone School; Member, Veteran Wireless Operators Association), state in their preface to *Radio Telegraphy and Telephony*:

"Many years of practical experience devoted exclusively to research and, especially, to instructing students of radio communication, have given the authors the incentive to prepare the text in this book, with the expectation that it may not only be of instructional value to non-technical students and readers generally, but that it may serve the radio field as a practical handbook." We believe this publication will meet these expectations.

Radio Telegraphy and Telephony, by Duncan and Drew, is in the category of Morecroft's *Principles of Radio Communication*, Robinson's *Manual of Radio Telegraphy and Telephony*, and the Signal Corps' book *The Principles Underlying Radio Communication*, although it is not as highly technical as the first two. Its merit lies principally in its broad, modern consideration of the phases of radio transmission and reception; its clarity with accuracy; its explanatory detail on certain points which have ever been "stumbling blocks" to most radio men.

An example of this detail is observed in the paragraph which reads:

"Many persons invariably inquire as to the derivation of some of the well-known constants that are used in radio formulas, particularly the constant $2\pi f$ for reactance. Therefore a brief discussion on this topic is given here." (Then follows a two-and-a-half-page diagnosis of this constant.)

Seven pages are devoted to answering the question, "How does a circuit oscillate?"

In addition to the presentation, earlier in the book, of the standard textbook "explanation" of electricity, there are thirteen pages devoted to the electron theory to show the present accepted answer to the question, "What is electricity?"

A.C. circuit-supply devices are analyzed and particular consideration is given to "why" and "how" alternating current is changed into direct current.

We would like to see about twenty additional illustrations. It is probably too much to hope for additional pages to complete certain topics, which are hardly more than referred to, without going into another volume.

It is a genuine pleasure to note that there are practically no typographical errors. We did not observe any diagrammatic inaccuracies. (R. D. W.)

Home Talkies

(Continued from page 65)

backward or forward the slight amount necessary to obtain the exact speed absolutely necessary; and then the "fine set" lock-screw is tightened. Once synchronism has been obtained, it will continue regardless of the projector speed, the sounds being heard at the exact instant the corresponding picture appears.

As all ordinary phonograph records are made at 78 r.p.m., it is necessary to obtain a different rotational speed of the turntable when it is desired to use them alone or as an incidental accompaniment to non-synchronous films, and this is accomplished by sliding the rubber-tired drive-wheel in, toward the center of the record, until a rate of 78 r.p.m. has been obtained. The scale pointer will be at 180 on the scale and is reached quickly by loosening the "rough-set" screw which locks the scale-pointer to the threaded, quarter-inch rod (24 threads per inch); releasing the scale-pointer from mesh at 45, and permitting it to be enmeshed at 180 without disturbing the fine (vernier) adjustment knob.

After the turntable speed has once been accurately adjusted, it should not be changed, if voice sounds a little "off key," like a phonograph running down or being wound up; this is easily corrected by slightly changing the speed of the projector, and is a final adjustment. No more is necessary, after plugging the phonograph pick-up leads into the detector socket and the record is run through the audio system of the radio set in the manner usual with electric pick-ups (the reproducer, preferably, is placed in the rear of the picture screen to lend realism).

To start a "performance," place the ("loud" steel) needle of the pick-up exactly at arrow mark on record, frame and focus "start" on screen, snap the switch of projector motor, and enjoy yourself with a perfect home "talkie."

W2XBS

This R. C. A. television station is now transmitting daily from 7-11 P. M. on a wave channel of from 2000-2100 kilocycles. Transmitted pictures consist of sixty horizontal lines, each divided into seventy-two elements laterally. Twenty pictures are scanned per second. The new daily schedule (E.S.T.) will permit experimenters to observe signs, photographs, and views of persons.

Moore-Daniels Receiver

(Continued from page 59)

Placement of Parts

Mount the condensers on the base, spacing carefully so that the mounting holes are in an exact straight line, and exactly the right distance back of the panel, so that the shafts which pass through their centers will also line up perfectly with the center of the dials. These mountings will well repay more than ordinary care; for the slightest deviation will cause the condensers to operate sluggishly, and make them stick in spots, which in turn will render fine tuning difficult.

When the condensers have been mounted, assemble the dials and panel and attach it to the baseboard. If the condenser mounting job was correct, the dials will attach smoothly to the condensers. If they do not, remove the condensers from the baseboard and, with a small rat-tail file, enlarge the holes in the baseboard in the requisite direction. Then replace the condensers leaving the final tightening of the mounting screws until the shafts are completely connected.

Coil Adjustments

Now put in the coils and sockets.

Each coil is seen behind its associated condenser, the antenna coil being at the extreme left.

In order to accommodate the moving primary, it is necessary to mount the first coil with its axis parallel to the panel and baseboard. The second coil is mounted at right angles, extending from front to back of the set, and centered on the axis line of the first coil. The third coil is at the right, in a vertical position, and also directly on the axis line of the first coil. By so arranging them, any currents induced in one side of any coil are balanced out by the exactly equal and opposite currents induced in the other side of the same coil.

Wiring Procedure

Now, screw a soldering lug under each of the front mounting screws of the audio transformers. Connect a wire to each of these lugs, and to the "A—" post on the cable plug. Then run wires from this to each of the other parts which are at "A—" potential. Keep these wires close to the baseboard and, wherever possible, at least a quarter of an inch from the instruments. In some cases it will not be possible, but do it where convenient. Then start a wire at the "A+" post on the plug and complete the positive filament wiring, winding the wire wherever possible around the already connected "A—" wires.

This is the start of our "cabled" wiring. As the wiring progresses, every lead which comes from the lower side (on the schematic) of a tube, coil or condenser should be wired into the cable wherever possible; even though adopting this course instead of direct point-to-point wiring may lengthen some of the leads considerably. The one exception to this rule is in the leads to the neutralizing condenser. These, and all of the leads coming from the top side (on the schematic) of the coils, condensers, and other instruments, should be kept as short as

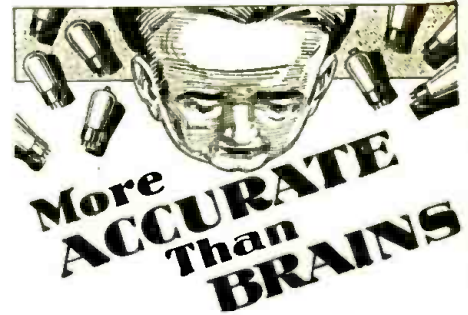

Amperite-controlled tubes are correctly controlled tubes. Amperite automatically regulates the filament supply to your tubes despite "A" voltage variations—more accurately than you can do it with fine meters and hand rheostats. Tube life is prolonged—reception improved. Insist on Amperite by name. A type for every tube—A.C. or D.C. \$1.10 with mounting in (U. S. A.) at all dealers.

Radiall Company
10 FRANKLIN ST., NEW YORK
Write Dept. RC-8

FREE "Amperite Blue Book" of modern circuits and valuable construction data.

AMPERITE
REG. U.S. PAT. OFF.
The "SELF-ADJUSTING" Rheostat

Do You Want to Break DX RECORDS?

Contrary to public opinion, it is possible to work greater distances today than ever before, particularly on short waves. But, with the usual broadcast receiver, made primarily for powerful signals, DX is not feasible. With the usual short-wave receiver, combined with average amateur skill, super-reception is difficult to attain.

Would you like to tune in Java, India, Siberia, Holland, England and Germany in one evening, via short waves? Would you like to tune in stations from coast to coast, the Mexican stations, many Canadian stations, and certain European stations on broadcast wave lengths?

It's just a question of precise details. Thus the GRID LEAK CLAROSTAT will provide precise detector action. The VOLUME CONTROL CLAROSTAT will provide razor-sharp regeneration. The HUM-DINGER will provide correct grid bias for screen grid tubes. And so on. The story is too long to be told here, so—

WRITE for Clarostat literature on how to improve your radio set no matter what it may be. Better still, send 25c. in stamps or coin for "The Gateway to Better Radio"—32 pages, 88 illustrations, and over 20,000 words of practical radio data.

CLAROSTAT MFG. CO., Inc.

Specialists in Radio Aids

295-7 N. 6th St., Brooklyn, N. Y.

\$100 WEEK
FOR YOU

SELLING — Biggest Company - Largest Line
CLOUTS EXPERIENCE UNNECESSARY
NECKWEAR & UNDERWEAR **SAMPLE** Million Dollar Stock Back of
SHIRTS **OUTFIT** Year Samples. **WRITE**
FREE CARLTON HILLS, INC. DEPT. 314 75th Ave., New York 560-N

FREE!

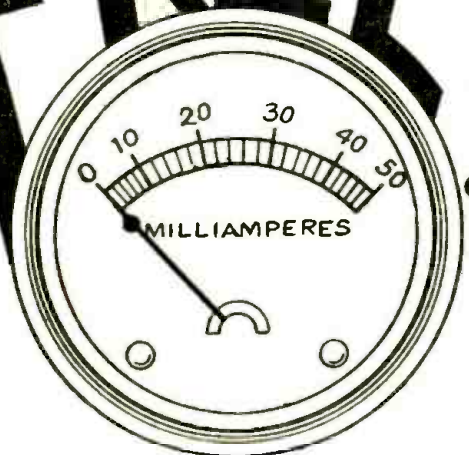

The Very Meter You Want Most!

Take Your Choice of 9 Instruments!

YOU finish building a set or power pack. You want to test it for voltage and current. You need some particular meter to make the test complete. Always the necessity for that meter, like recurring hunger! What wouldn't you give to have that meter here, NOW! No more need to endure such irritating deprivation. You are hereby given your choice of any one of nine different meters free! Please use the coupon.

CHOOSE ONE OF THESE NINE METERS!

- | | | |
|---|--|---|
| <input type="checkbox"/> 0-6 Voltmeter D.C. No. 326 | <input type="checkbox"/> 0-10 Amperes D.C. No. 338 | <input type="checkbox"/> 0-100 Milliamp. D.C. No. 390 |
| <input type="checkbox"/> 0-50 Voltmeter D.C. No. 337 | <input type="checkbox"/> 0-25 Milliamp. D.C. No. 325 | <input type="checkbox"/> 0-300 Milliamp. D.C. No. 399 |
| <input type="checkbox"/> 6-Vt Chge Tester D.C. No. 23 | <input type="checkbox"/> 0-50 Milliamp. D.C. No. 350 | <input type="checkbox"/> 0-400 Milliamp. D.C. No. 394 |

Put a cross in the square next to the meter you desire, and fill out and return coupon below. All meters except No. 23 are panel mount types; size of hole, 2 5/64"

WHAT RADIO COMPANIONSHIP DO YOU ENJOY?

ARE you meeting weekly the best minds of radio? Do you keep abreast of all the new circuits, the intimate details on perfecting existing sets, and get the inside track on sensitivity, distance reception, tonal quality, and how to achieve them? Do you keep fully abreast of the news of radio, technical and non-technical? If not, here is your chance to enjoy the writings of Dr. Lee De Forest, McMurdo Silver, J. E. Anderson, Herman Bernard and a host of other radio engineers who contribute their knowledge to you through the medium of Radio World, the first and only illustrated national radio weekly (eighth year!).

You will find Radio World specializes in most intimate revelations of the ins and outs of the best circuits, with technical accuracy second to none. Enjoy the weekly companionship of Radio World's famous contributors, and glean the news of radio, from the four quarters of the earth.

Short waves? Radio World will tell you all about them. Extremely sensitive broadcast receivers? Their construction and operation are fully discussed with confident regularity. Power supplies—push-pull or otherwise? AC receivers? Screen grid tubes? Large receivers that give a super-abundance of performance—small, economical receivers that give performance out of all comparison to their size? Automatic volume controls? Band-pass filters? New tubes? Are you interested in these? Then you're interested in Radio World. Send \$1 now for 8 weeks subscription, one copy a week (regularly \$1.20) and meter you select will be sent FREE!

RADIO WORLD, 145 W. 45th St., N. Y. C.
Published Weekly—All Newsstands—15c copy—
\$1.50, 3 months—\$3, 6 months—\$6 a year.

RADIO WORLD
145 West 45th Street, New York City
(Just East of Broadway)

Enclosed please find \$1 for which send me Radio World for eight weeks (one copy each week), and also send me FREE, at once, the one meter checked below.

- | | | |
|----------------------------------|----------------------------------|----------------------------------|
| <input type="checkbox"/> No. 326 | <input type="checkbox"/> No. 338 | <input type="checkbox"/> No. 390 |
| <input type="checkbox"/> No. 337 | <input type="checkbox"/> No. 325 | <input type="checkbox"/> No. 399 |
| <input type="checkbox"/> No. 23 | <input type="checkbox"/> No. 350 | <input type="checkbox"/> No. 394 |

Name

Street Address

City State

5-DAY MONEY-BACK GUARANTEE

MOORE-DANIELS DX5

Excerpts from a letter of a builder:

- "156 stations in 3 nights"
- "Pacific Coast before 9 P. M."
- "Havana as strong as Chicago"
- "I also heard a station in Colon, Panama"

**SPECIFIED PARTS
KITS — COILS**

Blue Prints \$1.00

CUSTOM BUILT MODELS

MOORE RADIO Co.

76 Cortlandt St. (3rd floor), New York City



Without any knowledge of Music or Notes you play in a few minutes, perfect like an artist, latest hits, songs and dances. Every instrument guaranteed. Interesting Circular C and roll list mailed free.

TREASURE SALES CO., 1690 Boston Road, New York

Buy from RADIO-CRAFT advertisers—they are reliable and well-known.

Orders-Inquiries

60 pages
Send for FREE Copy

Can be Secured by MAIL

POLK'S REFERENCE BOOK and Mailing List Catalog

Gives counts and prices on over 8,000 different lines of business. No matter what your business, in this book you will find the number of your prospective customers listed. Valuable information showing how to use the mails to secure orders and inquiries for your products or services is given.

Write for FREE Copy
R. L. POLK & CO., Detroit, Mich.

Largest City Directory Publishers in the World. Branches in Principal Cities. Mailing List Consultants—Business Statistics Producers of Direct Mail Advertising.

can be done and, as well, carefully separated from all other wiring.

After completing the filament wiring, put in the grid and plate leads of the R.F. and detector tubes, and also the other wiring which is at high R.F. potentials, such as the leads to the neutralizing condenser and, as already mentioned, these leads should be kept as direct and well away from the other instruments as can be done. Then connect the other leads from the high sides of the R.F. chokes, etc., putting them in the cable whenever convenient, and carefully avoiding the high-potential leads. Wire in the "C—" leads, twisting them, too, into the cable. Finally, put in the "B—" leads, which complete the wiring with the exception of the grid and plate leads of the audio amplifier. These also are wound on the cable.

The resulting job, as shown in the illustrations, will have a large cable running from the cable plug to the end of the channel between the audio and R.F. sections of the receiver, with smaller side branches, finally ending up in single wires. The effect of these wires, all wound close together, is exactly the same as if they were separated and additional by-pass condensers were put in the circuit across each of the wires.

Instead of a single long metallic shaft being used to connect the right-hand dial and the two condensers which it tunes, three shorter shafts are used with insulating couplings to connect them together. This is necessary, for both stator and rotor of each of these condensers are connected to the high-potential sides of their respective R.F. circuits; thus necessitating that they be carefully insulated from each other. They should be insulated also from the dial to prevent "hand capacity" effects.

Testing and Operation

When all connected, touching the grid of the detector tube should produce a loud squeal in the speaker, and touching the cap of the screen-grid tube should produce a click.

Set the dials at 80; place the primary of the antenna coil at an angle of about 45°. Adjust the rheostat to about three-quarters "on." Now vary the regeneration condenser; the receiver should go into oscillation at about half of its full capacity. If it either will not oscillate, or oscillates continuously, adjust the neutralizing condenser until it goes in or comes out at the proper point. Then set the dials at 20 and try again. When a position of the neutralizing condenser is found, at which the receiver can be put in oscillation at any wavelength by manipulating the regeneration control, the neutralizing adjustment can remain fixed unless the second R.F. tube is replaced by one of violently differing characteristics.

Now rotate the two dials in unison until a station is received, then vary the antenna condenser until it reaches its maximum volume. Reset the antenna condenser dial so that, with the station at maximum volume, the dials read alike. Some variation will be experienced with changes in the position of the antenna coil, and at the high and low ends of the band; but, in the main, the dials will be found to run very close together.

(At this point we diverge, to say that you can let this receiver squeal without any fear of breaking up the reception of other listeners. The screen-grid stage, as used in this receiver, positively will not be thrown into oscillation by any manipulation of the panel controls, and consequently the set cannot radiate.)

Parts Data

The input coil has a primary and a secondary. For maximum coupling, the separation between the wire of the primary coil and that of the secondary coil is only about one-eighth inch. The primary has 18 turns of cotton covered wire wound for a distance of one-half inch and the secondary has 77 turns wound on the same size tube: two inches in diameter.

This might be called the screen grid input coil, rather than the antenna coil. However, the next coil under consideration is the screen grid output coil. Like the input coil, it is supported three-quarters of an inch from the baseboard; two support brackets are used for this coil while the input coil requires only one. The secondary of this coil has 77 turns of wire and the coil is tapped in the middle. The primary is wound tightly over one end of the secondary for a distance of one-half inch, or 18 turns, also on a two-inch tube.

The coil design for the detector input unit is somewhat different. The coil mounts vertically on two brackets, as the illustrations show, and the winding of 77 turns starts 1 3/8 inches from the baseboard. This coil has but one layer and it is tapped at the 22nd turn from one end. The winding distance for 77 turns will be 2 1/4 inches.

Of course, these coil values are not of any value unless the correct tuning capacities are used. With the right variable condensers the entire broadcast range may be covered with a bit to spare at both ends. For those who prefer to use specified equipment, the following official list of parts is appended:

List of Parts

- 1—Set (3) Moore-Daniels Coils
- 5—Transcontinental R.F. Choke Coils
- 5—Air Gap Sockets
- 2—Hammarlund (illum.) Drum Dials
- 3—Hammarlund "midline" Variable Condensers, .0005 mfd.
- 1—Hammerlund "neut" Condenser
- 3—Hammarlund "universal" Couplings
- 1—Precise "microdenser," 32 mmfd.
- 1—Potter "aristocrat" F.C., .00025 mfd.
- 1—Potter "aristocrat" F.C., .001 mfd.
- 4—Potter "by-pass" Condensers, 0.5 mfd.
- 1—Silver-Marshall No. 255 Audio Unit
- 1—Silver Marshall No. 256 Audio Unit
- 1—Silver-Marshall No. 251 Output Unit
- 1—DeJur 3 meg. Grid Leak, with mount
- 1—DeJur 5-tube "thermatrol," mounted.
- 1—Hagel plug and cable, 7 wires
- 1—Filament Switch
- 5—Eby "junior" Binding Posts
- 1—Flexible Resistance, Electrad, 500 ohms
- 1—Tapped Resistor, 5-10 ohms
- 1—7x24 Panel, Drilled and Engraved.
- 1—11x23 Subpanel, drilled
- 1—Roll flexible rubber-covered wire

42 years
of
enduring quality



42 years
of
enduring quality

PUBLIC ADDRESS SYSTEMS

installed with AMPLION sound equipment
GIVE SUPERIOR PERFORMANCE

With a background of 42 years of success in the acoustic field, Amplion is prepared to offer public address equipment of unsurpassed dependability, for theatres, hotels, auditoriums, hospitals, clubs, railroad depots, county fairs, etc.

WANTED

We need RADIO ENGINEERS in all parts of the country for making Public Address Installations. If interested file your name, address, training, and experience, together with references, with

PUBLIC ADDRESS DEPT.

We have ready for IMMEDIATE DELIVERY and QUICK INSTALLATION

Group address equipment of unsurpassed reliability as follows:

- Amplion Giant Dynamic Air Column Units
- Amplion Exponential Air Column Horns
- Amplion Exciters
- Amplion Microphones
- Amplion Microphone Amplifiers
- Amplion Electric Phonograph Pick-ups
- Amplion Microphone Mixers

Amplion is the ONE place in America where you can purchase the complete installation or any part of the equipment as desired. Write for new catalog and profitable Amplion proposition to competent engineers

AMPLION CORP. OF AMERICA, 133 W. 21st Street, New York

S. Gernsback's Radio Encyclopedia

THE FIRST RADIO ENCYCLOPEDIA EVER PUBLISHED



Size
9 x 12"
549
Illus.

168
Pages
1930
Definitions

SPECIAL PRICE \$1.49

Edited by SIDNEY GERNSBACK, Author of "Wireless Course in Twenty Lessons"—"One Thousand and One Formulas"—"Practical Electricity Course"—"The Radio Educator," etc.

S. GERNSBACK'S RADIO ENCYCLOPEDIA is the only standard work ever published in America attempting to classify alphabetically the countless words used in the highly specialized science of RADIO. The ENCYCLOPEDIA is written in plain English so that everybody can understand the definitions and descriptions.

No expense has been spared, covering over two years in compilation, to make it worthy a place in your library.

It is published in one volume—168 pages—size 9 x 12 inches, nearly an inch thick and nicely accommodates the beautiful illustrations and the large, easy to read type.

The work contains 1,930 definitions, 549 photographs, drawings and diagrams.

REMEMBER THIS IS A REAL ENCYCLOPEDIA—NOT A DICTIONARY—and very few of the things described and illustrated in this volume can be found in any dictionary, or any other encyclopedia.

The book contains as a supplement a classified cross index designed to bring together radio references under one heading having relations in common.

All circuits new and old are described by word and picture and every part and apparatus used in Radio is explained and made understandable by means of photographs and drawings.

The volume is printed upon fine paper—bound in full black Keratol, marbled paper fly leaves and end sheets, with the title stamped in gold.

SEND NO MONEY

Just forward the Coupon below and the Encyclopedia will be sent you at once. You pay the Postman \$1.49 plus postage on delivery and if the book is not satisfactory return it and your money will be paid back at once without any questions.

ISKOR PRESS, Inc.

286 Fifth Ave., New York

ISKOR PRESS, Inc.,
286 Fifth Avenue,
New York.

Send me one copy of Sidney Gernsback's First Radio Encyclopedia in one volume as advertised. I will pay postman \$1.49 plus postage on delivery.

NAME
ADDRESS
TOWN and STATE.....

Barawik - the Old Reliable

RADIO SERVICE

What's New in Radio?

Screen-grid tubes and sets, single-dial control and dynamic speakers, were used by custom set builders long before set manufacturers adopted them. Barawik customers who have followed Barawik Catalog and Guide are always a step ahead in real radio information. The vital things in radio, the real advances and improvements are considered, tested and listed by Barawik and made available to thousands of real radio fans long before the general public gets them.

Keep up to date and ahead of the procession by using Barawik service, by referring constantly to the Barawik Radio Guide.



SPECIAL SERVICE TO AMATEURS

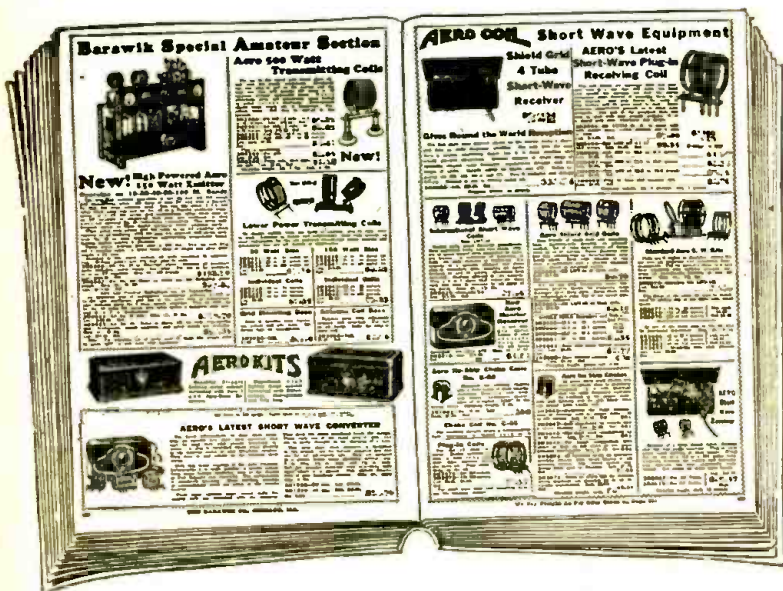

The BARAWIK COMPANY is the pioneer radio house in supplying short wave equipment, both receivers and transmitters, to amateurs. All the various parts, kits and accessories used in building short wave sets, converters, transmitters, etc., are carried in stock by us, ready for immediate shipment to all parts of the world.

The following Short Wave Circuits are carried in stock by us, ready for immediate delivery to you:

- | | |
|-------------------------------------|------------------------------|
| Aero Coil Kits | Ellis Coils |
| Aero Short Wave Receivers | National Parts and Receivers |
| Aero Transmitters | Karas Parts and Receivers |
| B. E. L. Receivers and Transmitters | Short Wave Converters |
| Hammarlund Kits | Public Address Systems |
| Portable Receivers and Transmitters | Television Equipment |
| Cardwell Parts | Etc., Etc., Etc. |
| Pilot Kits | |

Our central location insures fast service to customers in all parts of the country.

Radio-Craft readers will find in the BARAWIK Radio Catalog and Guide thousands of choicest bargains—the very things you need and use in everyday life. If you haven't a copy of this big Cyclopaedia, send for it at once. It is free—mail the handy coupon below, while it is before you. Send today—now!

BARAWIK CO., 348 Canal Station, Chicago, Ill.

Dear Sirs:

Please send me your Big Radio Guide, Catalog and Bargain Book showing the new developments in radio and the many bargains in radio goods, sporting goods and the new lines for 1929 that you advertise.

Name

Address

City State

NEW Developments Coming?

With shield-grid A.C., condenser type speakers, and short wave making speedy headway and television becoming more and more advanced, what startling announcements will come next? These and many other new developments will be available to you from time to time by getting your name enrolled on the Barawik list.

YOU'LL BE MONEY AHEAD

You'll be time and money ahead by sending your name to us now and getting our catalogs and bulletins regularly. Then, when new developments are announced, you'll be the first to know about them.

How to Save Money

The Barawik Guide is the surest way to save money on sets, radio parts, kits, accessories, short wave and thousands of necessities.

In addition to a full line of the best known radio parts, kits and sets, BARAWIK offers to you a complete line of everything in the radio field—sets, radio furniture, tubes, power units, portable receivers, dynamic and other speakers, parts and kits for all popular circuits, short wave and television supplies, short wave transmitters, radiophones, public address systems, novelties, etc., as advertised in Radio-Craft and other radio publications.

BARAWIK also sells, at lowest money-saving prices, to customers the world over, auto tires and tubes, auto accessories, electrical goods, lighting fixtures, wiring material, household appliances, stoves, vacuum cleaners, washing machines, camping equipment, sporting goods, golf and baseball supplies, outing clothing and thousands of the things you and everyone else needs the year 'round for home, office, work and recreation.

Write us today—or use the handy coupon below and assure yourself of complete advance information on radio developments, and an opportunity to make big savings on everything you buy.

The Barawik Co.

348 Canal Station
Chicago, Ill.

Pick the **RADIO** Job you want ... and fill it

in only **9** months

By means of this "Big-League" home-training
sponsored by the Radio Corporation of America

WHY struggle along on less than \$45 a week? Why wait years for success that can be yours in only 9 months?

As a result of a marvelous new kind of home-study training in Radio, hundreds of men are today leading straight for financial independence! Radio pays from \$2,000 to \$25,000 a year. The work is thrilling ... the hours are short. Vacations with pay ... opportunities for seeing the world ... adventure galore!

Prepare at Home with this Big Laboratory Outfit

Get the "How" as well as the "Why" of Radio—with this expert training! Only an hour or so a day—in spare time—is all you need! As part of your course, you receive absolutely free of extra charge—a magnificent outlay of apparatus. With this outfit you learn to build fine sets and solve the problems that bring big pay.

Training sponsored by Radio Corporation of America

Our graduates are in big demand everywhere. They enjoy greater success because they're posted right up-to-the-minute in *everything* in Radio. Radio's progress each year is measured by the accomplishment of the great engineers at work in the research laboratories of RCA. This great organization sets the standards for the industry, and stands back of every lesson in the course.

Money Back if Not Satisfied

The lessons prepare you for success in all phases of Radio—manufacturing, servicing, selling, ship and shore broadcasting, Television and Photo-radiograms. A signed agreement backed by RCA assures you of complete satisfaction upon completion of the training—or your money will be promptly refunded.



FREE



**RADIO OPERATOR \$900-\$2000 PER MONTH
WITH ALL EXPENSES PAID**

**BROADCAST OPERATOR
\$1800 - \$4800 A YEAR**

**RADIO REPAIR MECHANIC
\$1800 - \$4000 A YEAR**

**RADIO INSPECTOR
\$2000 - \$4500 A YEAR**

Read This Thrilling Free Book

It gives you the real "dope" about Radio and describes in detail the famous training that has enabled us to place thousands of our students in fine positions, usually from 3 to 10 days after graduation. It may mean the turning point in your life. It tells in 50 fascinating pages and photos all about Radio's brilliant opportunities for adventure and success. Mail the coupon now—the book is absolutely free!

Radio Institute of America, Dept. R.C.-8
326 Broadway, New York

Radio Institute of America
Dept. R.C.-8
326 Broadway, New York, N. Y.

Gentlemen: Please send me your big FREE 50-page book which tells about the brilliant opportunities in Radio and about your famous laboratory-method of guaranteed radio instruction at home.

Name _____

Address _____

Announcing

a NEW Radio Thrill!

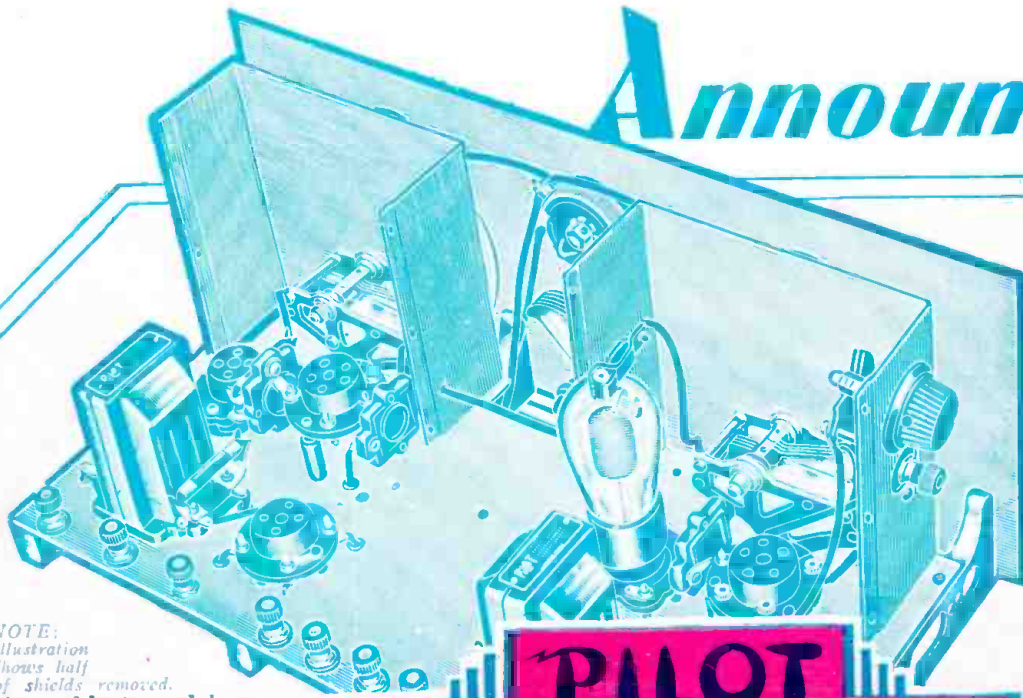

NOTE:
Illustration
shows half
of shields removed.
Assemble it and hear
it the same evening!

The Pilot Super-Wasp opens up the *Entire World* with Short-Wave and Broadcast Reception from 14 to 500 meters.

PILOT DOUBLE-DUTY

SHORT-WAVE
BAND

BROADCAST
BAND

SUPER WASP

TUNED SCREEN GRID 14 TO 500 METERS

Ordinary Broadcast Receivers cover only the 200 to 500 meter band.

Ordinary Short-Wave Receivers cover only 14 to 200 meters.

The double-duty Super-Wasp covers the entire Short-Wave and Broadcast Bands from 14 to 500 meters!

Two sets of plug-in coils are furnished.

The only Short-Wave Receiver having a stage of Tuned R.F. with Screen-Grid Tube, giving greatest Sensitivity and Selectivity.

Condenser-Controlled Regenerative Detector. All-drilled metal chassis.

Smooth operation, consistent results, easy to tune!

Splendid loud-speaker results.

With the Pilot Double-Duty Super-Wasp Kit you build a receiver that gets *everything* on the air, both Short-Wave and Broadcast Reception.

By means of interchangeable plug-in coils you change in a twinkling from Broadcast to Short-Wave and vice versa!

The greatest dissolver of distance ever created! The perfect all-wave all-round receiver. Designed and engineered by Robert S. Kruse, internationally known authority!

CUSTOM SET-BUILDERS PRICE

(Catalog No. K-110)
Including 2 sets of 5
coils each, full-sized
blue-print and complete
assembly data.

\$29⁵⁰

Slightly higher west of
the Rockies.

If There Is No Pilot Dealer In Your Locality, Write Us

Check These Features!

No. A.C. Hum pick-up. Completely shielded R.F. and Detector Stages eliminate hand detuning effects.

Low losses—ingenious design reduces all R.F. connections to one and a half inches or less!

Illuminated Vernier Dials for both condensers.

Simplicity of assembly due to "sectional cans" and minimum wiring. Assemble and operate it same evening!

On very first test received loud and clear broadcast programs from Chelmsford, England; Costa Rica, Central America; PCI Eindhoven, Holland; Manitoba, Canada, etc.

SEND FOR RADIO DESIGN

50c brings you one year's subscription to "Radio Design" Quarterly Magazine, chock-full of latest Radio, Short-Wave and Television Developments. "Radio Design," 103-U Broadway, Brooklyn, N.Y.

THE PILOT SUPER-WASP KIT IS MADE IN WORLD'S LARGEST RADIO PARTS PLANT!

Pilot Radio & Tube Corp.

323 BERRY ST.  BROOKLYN, N.Y.

ESTABLISHED 1906

TRADE MARK REG.